

LAPT 2SC2837

Silicon NPN Epitaxial Planar Transistor (Complement to type 2SA1186)

Application : Audio and General Purpose

Absolute maximum ratings (Ta=25°C)

Symbol	2SC2837	Unit
V _{CB0}	150	V
V _{CE0}	150	V
V _{EB0}	5	V
I _C	10	A
I _B	2	A
P _C	100(T _C =25°C)	W
T _J	150	°C
T _{stg}	-55 to +150	°C

Electrical Characteristics (Ta=25°C)

Symbol	Conditions	2SC2837	Unit
I _{CB0}	V _{CB} =150V	100max	μA
I _{EB0}	V _{EB} =5V	100max	μA
V _{(BR)CEO}	I _C =25mA	150min	V
h _{FE}	V _{CE} =4V, I _C =3V	50min*	
V _{CE(sat)}	I _C =5A, I _B =0.5A	2.0max	V
f _r	V _{CE} =12V, I _E =-1A	70typ	MHz
COB	V _{CB} =80V, f=1MHz	60typ	pF

*h_{FE} Rank \bar{O} (50 to 100), P(70 to 140), Y(90 to 180)

Typical Switching Characteristics (Common Emitter)

V _{CC} (V)	R _L (Ω)	I _C (A)	V _{B2} (V)	I _{B1} (mA)	I _{B2} (mA)	t _{on} (μs)	t _{stg} (μs)	t _f (μs)
60	12	5	-5	500	-500	0.2typ	1.4typ	0.35typ

External Dimensions MT-100(TO3P)

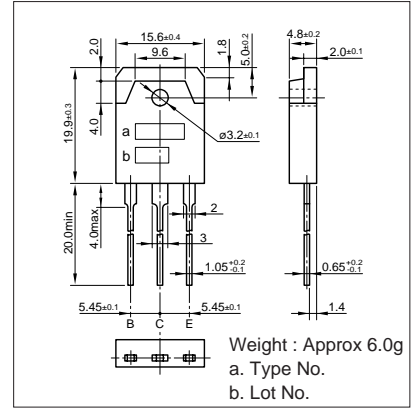

I_C-V_{CE} Characteristics (Typical)

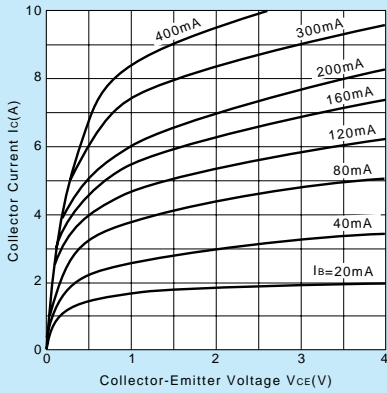

V_{CE(sat)}-I_B Characteristics (Typical)

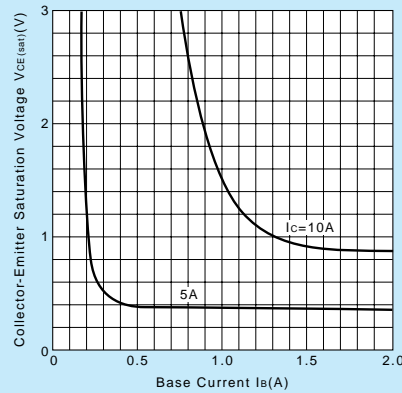

I_C-V_{BE} Temperature Characteristics (Typical)

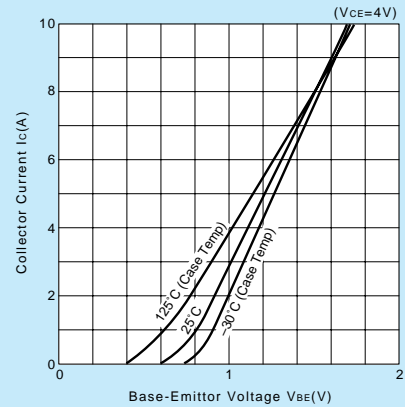

h_{FE}-I_C Characteristics (Typical)

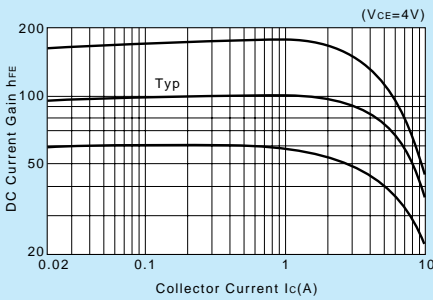

h_{FE}-I_C Temperature Characteristics (Typical)

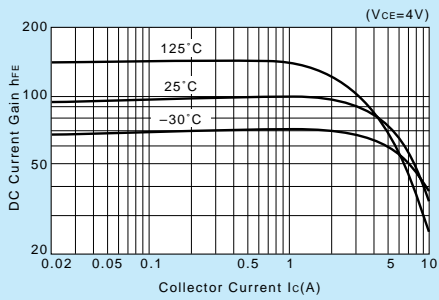

θ_{J-a}-t Characteristics

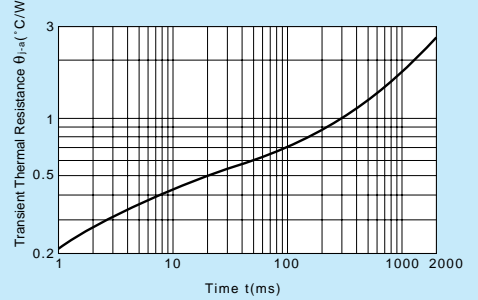

f_r-I_E Characteristics (Typical)

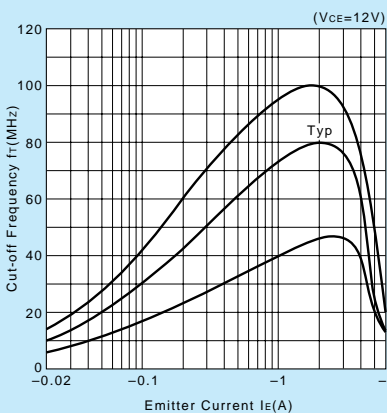

Safe Operating Area (Single Pulse)

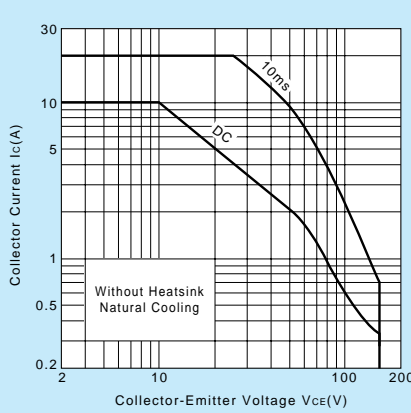

P_C-T_a Derating

