

FM PLL MPX

The TA7343AP is PLL FM stereo multiplex IC.
It is suitable for automotive applications and portable
radio applications because of space merit by the package
and wide supply voltage range.

FEATURES

- Excellent stereo LED sensitivity
: $V_L(ON) = 9mV_{rms}$ (Typ.)
- Suitable for LED driving : $I_{LED} = 20mA$ (Max.)
- Recommendable input voltage range
: $V_{in} = 200 \sim 700mV_{rms}$
- Operating supply voltage range : $V_{CC} = 3.5 \sim 12V$
- Excellent channel separation through
entire audio frequency range : $Sep = 45dB$ (Typ.)
- Low distortion : $THD = 0.08\%$ (Typ.) at $V_{in} = 200mV_{rms}$ (Stereo)
- Built-in compulsive monaural function. (The VCO is stopped when the pin⑦ is connected with the power supply line, and then the stereo indicator is turn off.)
- Easy adjustment (The monitored free running frequency of VCO is 38kHz at pin⑥.)

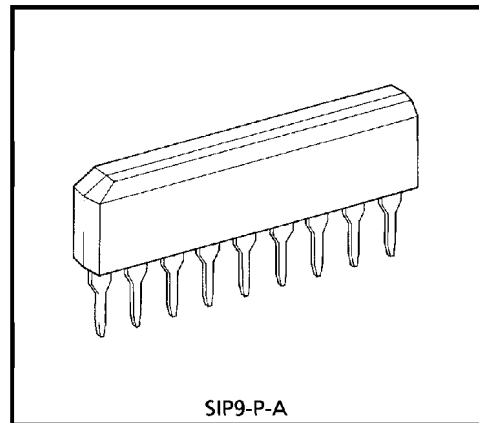

SIP9-P-A
Weight : 0.92g (Typ.)

© The information contained herein is presented only as a guide for the applications of our products. No responsibility is assumed by TOSHIBA CORPORATION for any infringements of intellectual property or other rights of the third parties which may result from its use. No license is granted by implication or otherwise under any intellectual property or other rights of TOSHIBA CORPORATION or others.
© These TOSHIBA products are intended for use in general commercial applications (office equipment, communication equipment, measuring equipment, domestic appliances, etc.). please make sure that you consult with us before you use these TOSHIBA products in equipment which requires extraordinarily high quality and/or reliability, and in equipment which may involve life threatening or critical application, including but not limited to such uses as atomic energy control, airplane or spaceship instrumentation, traffic signals, medical instrumentation, combustion control, all types of safety devices, etc. TOSHIBA cannot accept and hereby disclaims liability for any damage which may occur in case the TOSHIBA products are used in such equipment or applications without prior consultation with TOSHIBA.

BLOCK DIAGRAM

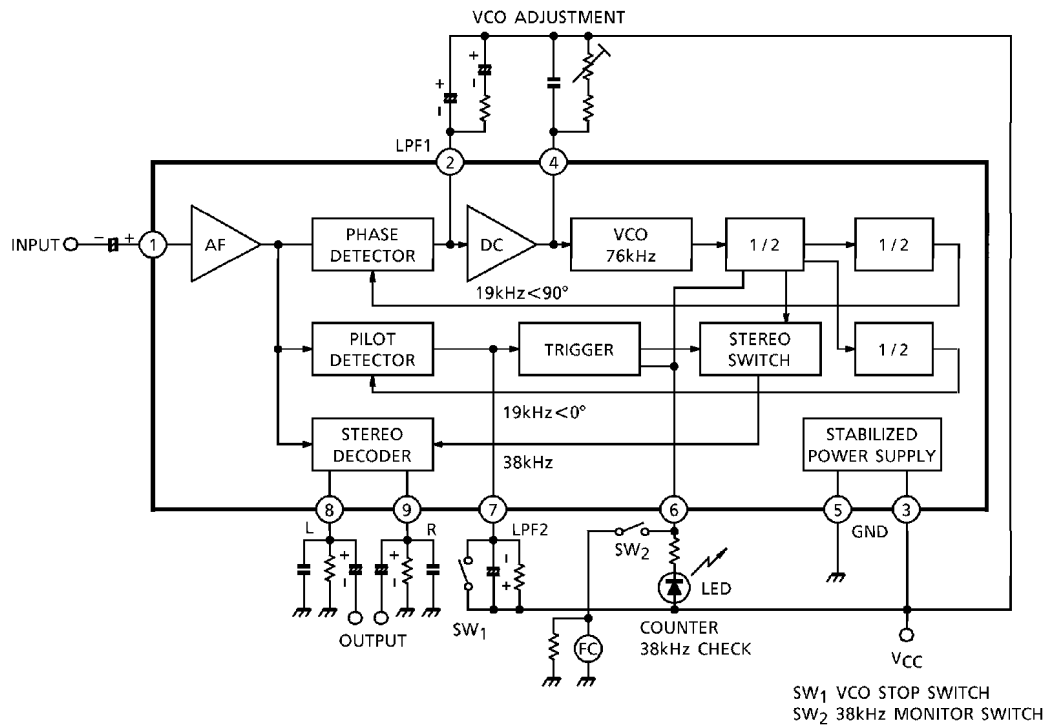

MAXIMUM RATINGS (Ta = 25°C)

CHARACTERISTIC	SYMBOL	RATING	UNIT
Supply Voltage	V _{CC}	12	V
LED Voltage	V _{LED}	16	V
LED Current	I _{LED}	20	mA
Power Dissipation	P _D (Note)	500	mW
Operating Temperature	T _{opr}	-30~75	°C
Storage Temperature	T _{stg}	-55~155	°C

(Note) Derated above Ta = 25°C in the proportion of 4mW/°C.

ELECTRICAL CHARACTERISTICS

1. DC characteristics (Ta = 25°C, V_{CC} = 8V, terminal voltage at no signal)

PIN No.	CHARACTERISTIC	SYMBOL	TYP.	UNIT
Pin①	INPUT	V1	3.5	V
Pin②	LPF 1	V2	6.6	V
Pin③	V _{CC}	V3	8.0	V
Pin④	VCO	V4	7.1	V
Pin⑤	GND	V5	0	V
Pin⑥	ST LED	V6	—	V
Pin⑦	LPF 2	V7	7.4	V
Pin⑧	L-ch OUTPUT	V8	4.0	V
Pin⑨	R-ch OUTPUT	V9	4.0	V

2. AC characteristics (Unless otherwise specified, $T_a = 25^\circ\text{C}$, $V_{CC} = 8\text{V}$, $f = 1\text{kHz}$)

CHARACTERISTIC		SYMBOL	TEST CIR-CUIT	TEST CONDITION	MIN.	TYP.	MAX.	UNIT	
Supply Current		I_{CC}	—	at LED off	—	11	18	mA	
Input Resistance		R_{IN}	—		—	33	—	$k\Omega$	
Max. Composite Signal Input Voltage		V_{in} MAX (STEREO)	—	L + R = 90%, P = 10% THD = 1%	—	900	—	mV_{rms}	
Separation		Sep	—	L + R = 180 mV_{rms} P = 20 mV_{rms}	36	45	—	dB	
Total Harmonic Distortion	Monaural	THD (MONAURAL)	—	$V_{in} = 200mV_{rms}$	—	0.08	0.3	%	
	Stereo	THD (STEREO)	—	L + R = 180 mV_{rms} P = 20 mV_{rms}	—	0.08	—		
Voltage Gain		G_V	—	$V_{in} = 200mV_{rms}$	-2.0	0	2.0	dB	
Channel Balance		CB	—	$V_{in} = 200mV_{rms}$	—	0	1.5	dB	
Stereo LED Sensitivity	ON	V_L (ON)	—	Pilot Input	—	9	15	mV_{rms}	
	OFF	V_L (OFF)	—		2	6	—		
Stereo LED Hysteresis		V_H	—	to turn off from LED turn on	—	3	—	mV_{rms}	
Capture Range		CR	—	P = 20 mV_{rms}	—	± 3	—	%	
Carrier Leak	19kHz	CL	—	P = 20 mV_{rms} L + R = 180 mV_{rms}	—	34	—	dB	
	38kHz				—	42	—		
SCA Rejection Ratio		SCA Rej	—	P = 20 mV_{rms} L + R = 160 mV_{rms} SCA = 20 mV_{rms} $f_{SCA} = 67\text{kHz}$	—	70	—	dB	
Signal to Noise Ratio		S/N	—	$V_{in} = 200mV_{rms}$ $f = 1\text{kHz}$, $R_g = 620\Omega$	—	74	—	dB	
Output Current (Pin⑧, Pin⑨)		I_{OUT}	—	$R_L = 3.3k\Omega$	$V_{CC} = 3.5\text{V}$	—	0.3	0.6	mA
					$V_{CC} = 8.0\text{V}$	—	1.2	1.8	
					$V_{CC} = 12\text{V}$	—	1.4	2.1	

TEST CIRCUIT

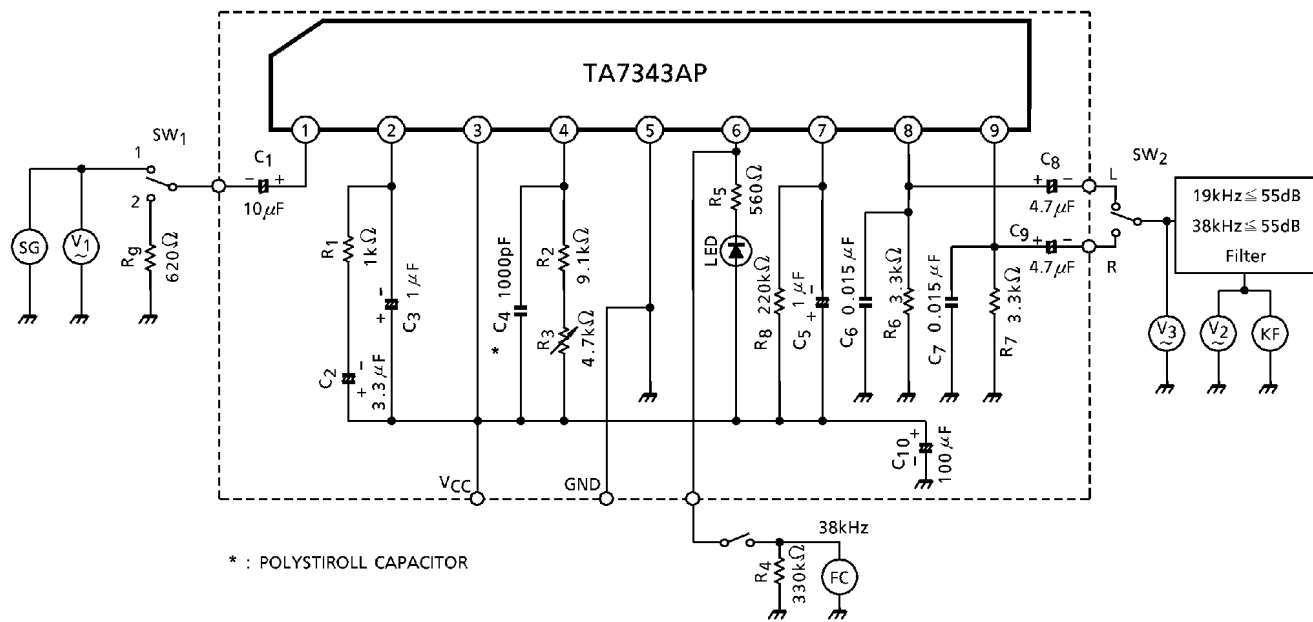

- SG : STEREO SIGNAL GENERATOR
- FC : FREQUENCY COUNTER
- V₁, V₂, V₃ : AC VOLTMETER
- KF : DISTORTION METER

EXTERNAL PARTS TABLE

PARTS No.	TYPICAL	PURPOSE	INFLUENCE		NOTE
			SMALLER THAN TYP.	GREATER THAN TYP.	
C ₁	10 μ F	Coupling	Separation is bad at 50~300Hz	"POP" noise is high	Input
C ₂	3.3 μ F	LPF at PLL	THD is bad at 5~10kHz (stereo)	Narrow capture range	—
C ₃	1 μ F				
R ₁	1k Ω				
C ₄	1000pF	VCO Free Running Frequency adjustment	C ₄ : Small→Wide capture range and large glitter		—
R ₂	9.1k Ω		C ₄ : Large→Narrow capture range		
R ₃	4.7k Ω VR				
R ₄	330k Ω	Monitor Load	—		—
R ₅	560 Ω	Rush Current Limiter	IC is damaged by the rush current	LED is dark	I _{LED} \leq 20mA
LED	—	Stereo Indicator	Usable for LED		
C ₆	0.015 μ F	Load and Diemphasis	Diemphasis (50 μ s)		C ₆ = 0.022 μ F for 75 μ s
R ₆	3.3k Ω		Output voltage is small	THD is bad for low V _{CC}	
C ₇	0.015 μ F	Load and Diemphasis	Diemphasis (50 μ s)		C ₇ = 0.022 μ F for 75 μ s
R ₇	3.3k Ω		Output voltage is small	THD is bad for low V _{CC}	
C ₈	4.7 μ F	Output Coupling	Frequency response is bad	"POP" noise is large	L-ch
C ₉	4.7 μ F	Output Coupling			R-ch
R ₈	220k Ω	LED Sensitivity Adjustment	V _L (ON) is large	V _L (ON) is small	—
C ₅	1 μ F	LPF at LED	THD is bad at 50~300Hz	Slow LED response	—

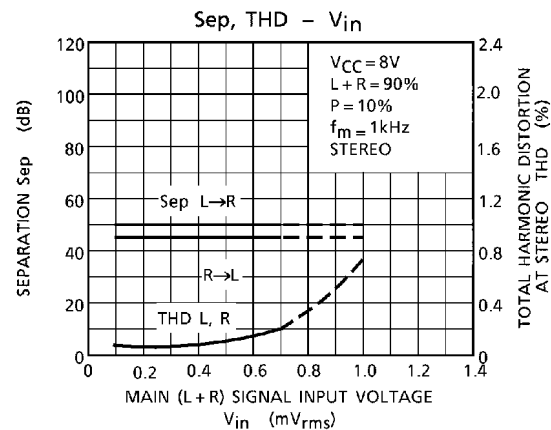
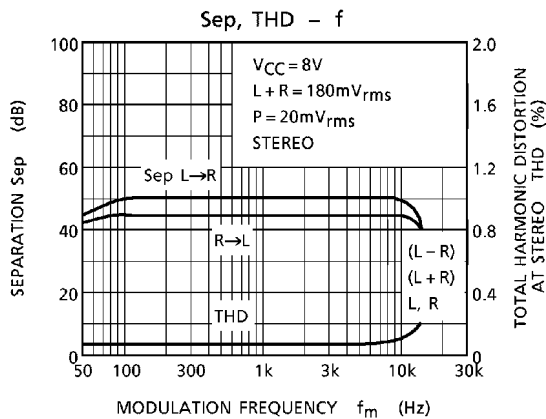
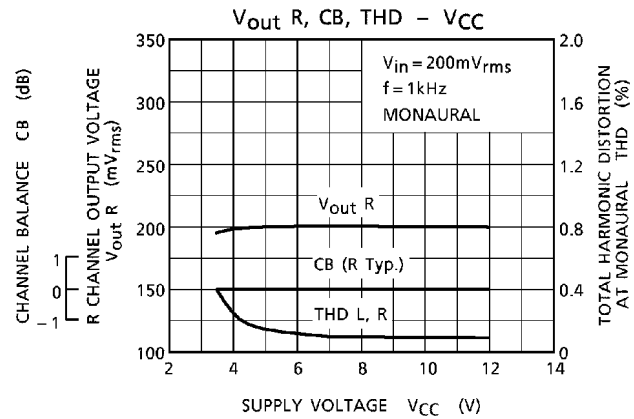
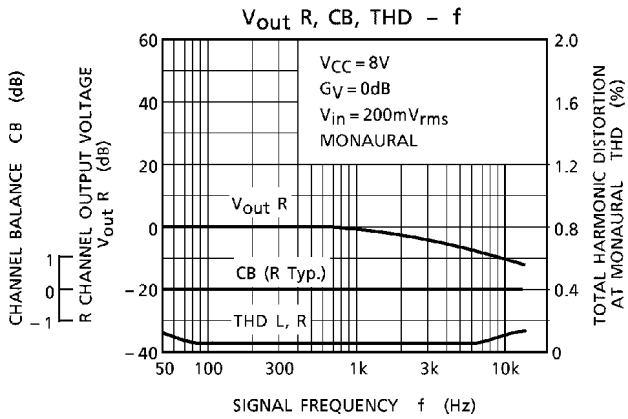
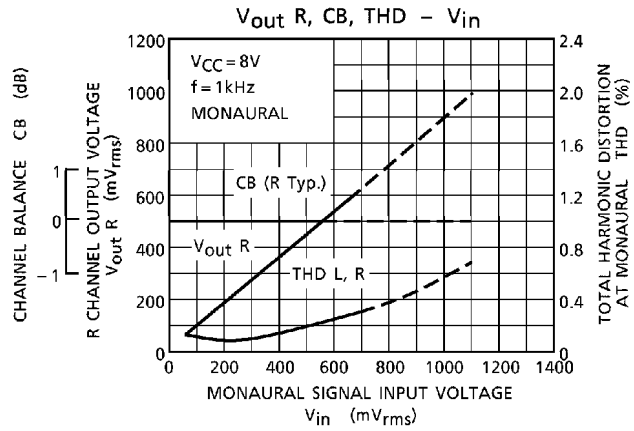
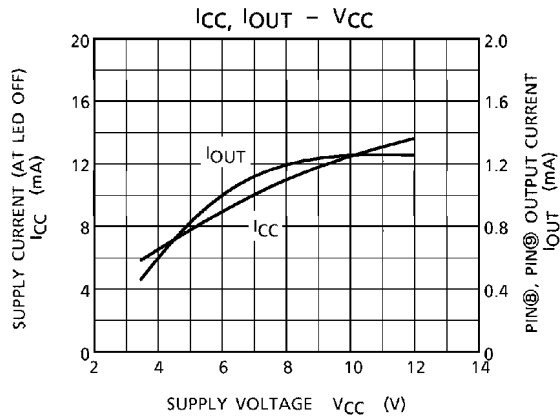

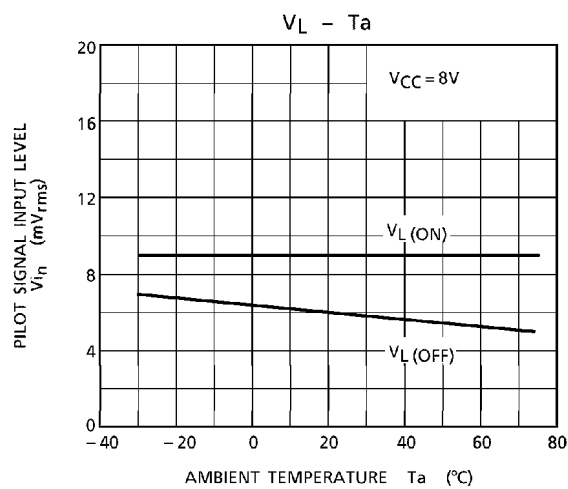
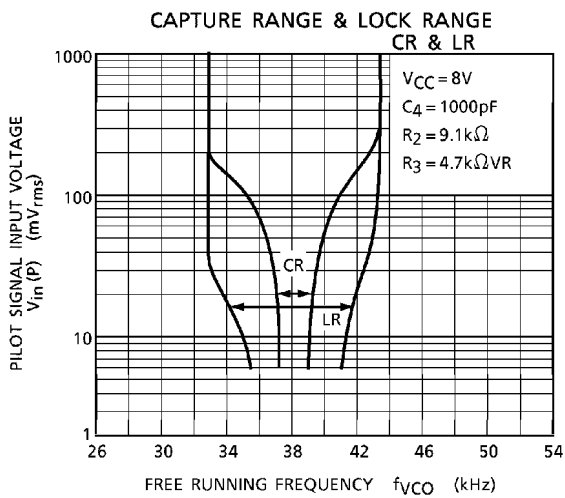
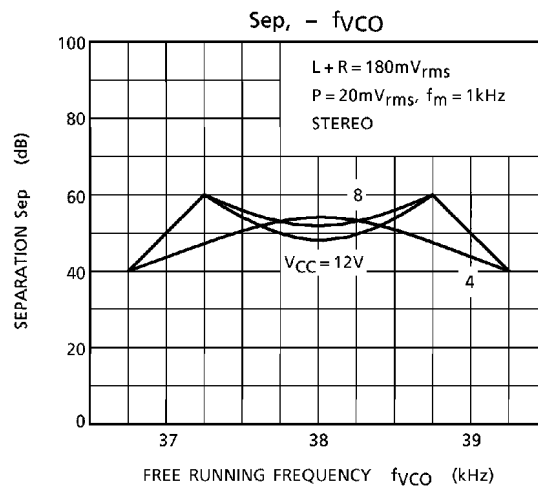
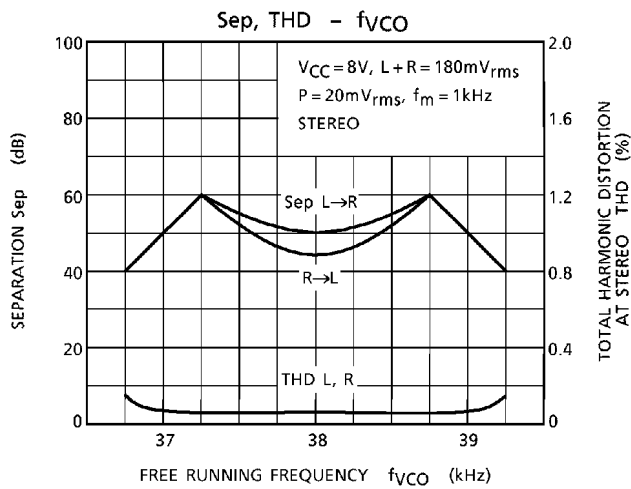
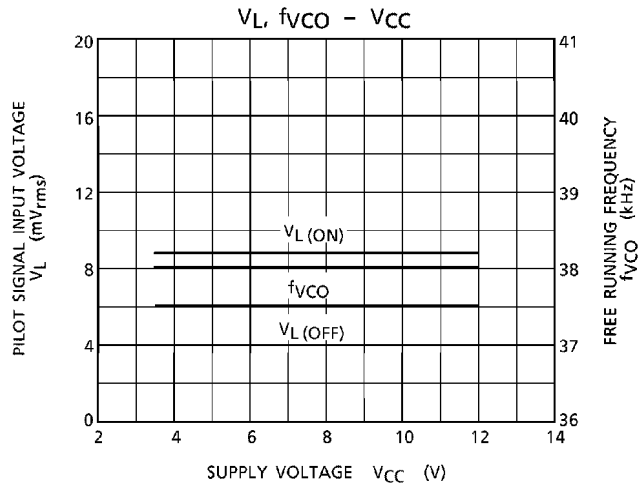
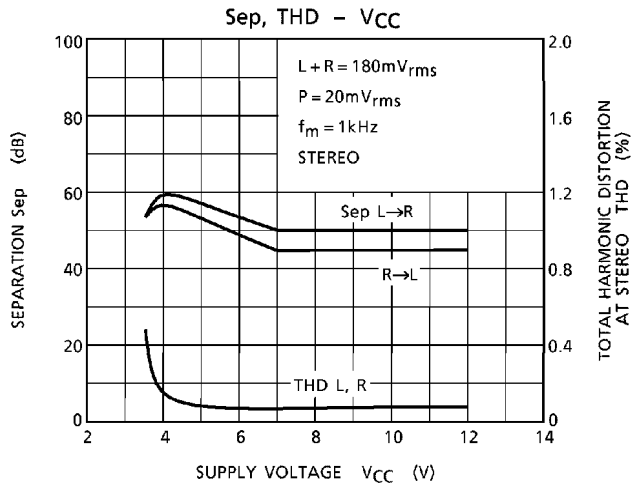

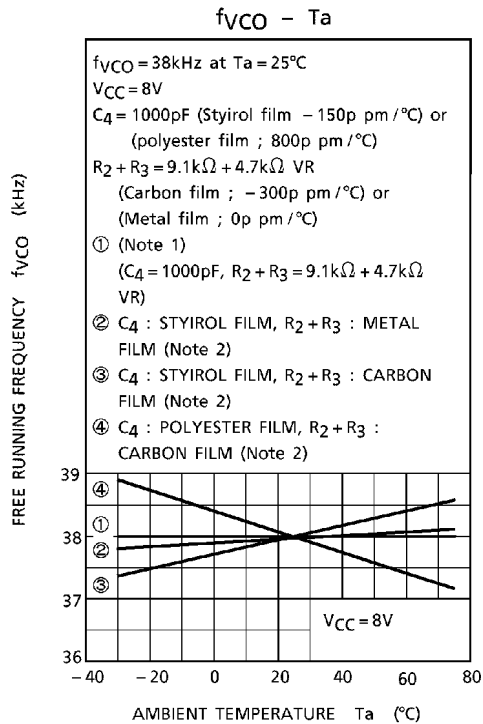
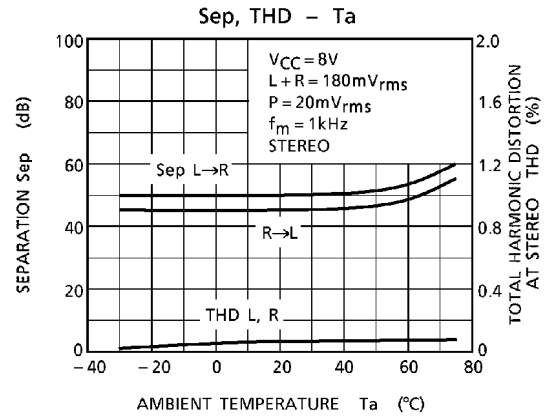
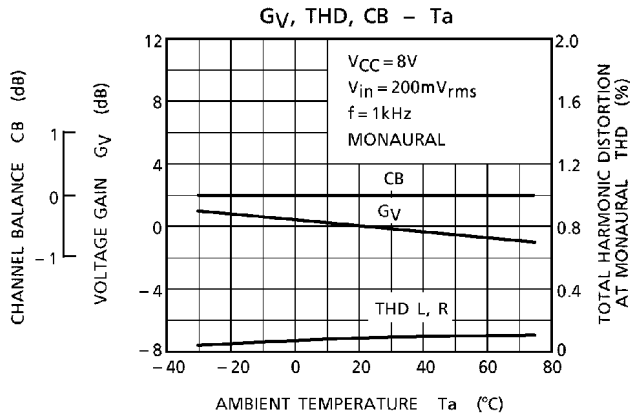

(Note 1) ① : With IC only put into a temperature test chamber

(Note 2) ②③④ : With IC, resistors and capacitors put into a temperature test chamber

OUTLINE DRAWING
SIP9-P-A

Unit : mm

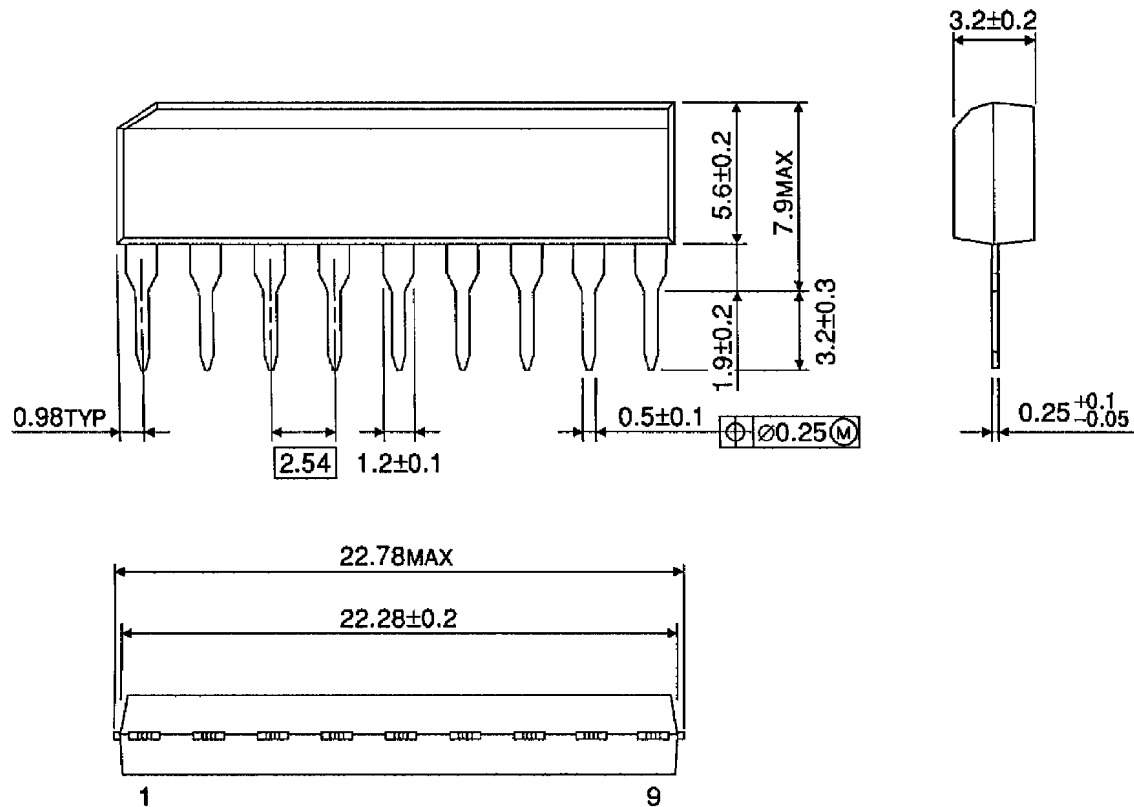

Weight : 0.92g (Typ.)