DS203 USER'S MANUAL

Contents

I Product Intro.....	2
II General Safety Rules	2
III Major Functions	2
IV Operation Precautions	2
V General Inspection	3
VI Functional Inspection.....	3
VII Firmware Upgrade	3
VIII Oscilloscope Familiarization.....	4
1. Interface and Buttons.....	4
2. Screen	5
2.1. Parameters	5
2.2.Functions of Channel Area.....	6
2.3.Functions of Detection Area.....	7
2.4.Menus.....	8
IX Application Example.....	9
1. Example 1 Measure simple signals.....	9
2. Example 2 Acquire a single signal.....	9
3. Example 3 Measure with Cursors.....	10
4. Example 4 Compare waveforms.....	11
5. Example 5 Save waveform images.....	12
X Operation Tips.....	13

I Product Intro

DS203 is a 5-trace 4-channel digital oscilloscope for common electronic engineering tasks. Its CPU is based on ARM Cortex M3, adopting FPGA to manage the control & data buffering of ADC. A built-in 2MB USB disk enables users to store waveforms & upgrade firmware. It also provides 4 application areas, convenient for users to load & upgrade at most 4 kinds of application firmware.

II General Safety Rules

To ensure your safety & avoid any damage to the device/connected products, please read the following precautions carefully. To avoid any possible dangers, please use this product according to the rules.

Avoid fire & physical injury.

Use appropriate power cord. Please use dedicated power cord which is certified in the country/region.

Connect & disconnect properly. Do not plug/unplug when the probe(s)/test lead(s) is connected to the voltage source. Before you plug/unplug current probes, please disconnect power to the circuit-under-test.

Observe all terminal ratings. To avoid fire/electric shock, please observe ratings & symbols on the product. Please read the user's manual carefully to know detailed info of the ratings before connecting the device.

Do not operate in humid environment.

Do not operate in inflammable/explosive environment.

Please keep the surface of the product clean & dry.

III Major Functions

Pocket-size oscilloscope DS203 helps you test, adjust & present electronic designs. Its functions include:

▼ 8M Hz bandwidth , 8-bit precision

▼ 2 analog channels: (CH_A, CH_B), 2 digital channels (CH_C, CH_D)

▼ **Calculation channels:** [CH_A]+[CH_B], [CH_A]-[CH_B], [CH_C][CH_D],
[CH_C]&[CH_D], REC_A, REC_B, REC_C, REC_D

▼ Sampling rate of any analog channel can reach 72 MS/s

▼ Record length of any channel can reach 4096 bits

▼ Users can save waveforms and upgrade firmware with a built-in 2M USB disk.

IV Operation Precaution

■ Temperature :

Operating Condition : +0°C to +50°C

Non-operating Condition : -20 °C to +60 °C

■ Humidity :

Operating Condition : high temperature : 40 °C to 50 °C , 0% to 60% RH

Operating Condition : low temperature : 0 °C to 40 °C , 10 to 90%RH

Non-operating Condition : high temperature : 40 °C to 60 °C , 5 to 60% RH

Non-operating Condition : low temperature : 0 °C to 40 °C , 5 to 90% RH

■ Parameters

Max transient-withstanding voltage is ± 400 V peak value.

Measure voltage range

Measure frequency range

Max input voltage of logic probe is ± 15 V peak value.

V General Inspection

When you get a new DS203 oscilloscope, it's suggested to inspect the product by following steps.

1 . Inspect for damage caused by shipping.

If the packaging carton or protection pad is seriously damaged, keep the package until you check the oscilloscope & accessories electrically and mechanically.

2 . Inspect the oscilloscope

Please contact us if following problems occur: (1) surface of device is damaged; (2) device can't work well; (3) device doesn't pass performance test

If damage is resulted from shipping, please keep the container & inform the shipping department/others responsible for this service.

VI Functional Inspection

Make a quick functional inspection to ensure this device works well. Please perform following steps:

1 . Turn on power supply; access the homepage of the oscilloscope.

2 . Connect the oscilloscope with standard signals (e.g.: square wave 20KHz, $V_{pp}=5V$); Set the switch on probe tip as 1X, plug oscilloscope probe to CH_A.

Check whether the measured values are consistent with standard values. It can be calibrated if the margin is narrow. Same for CH_B, CH_C & CH_D.

VII Firmware Upgrade

To upgrade the firmware, please perform following steps:

1. Open Web to access www.minidso.com, download the latest firmware of your oscilloscope to your PC.

2. Simultaneously press \blacktriangleright of DS203 and turn on power supply, enter DFU firmware upgrade mode.

3. Use USB to connect DS203 to your PC, A removable disk named "DFU V3_10_D" will appear on your PC. Copy the firmware to the root directory of this disk then restart DS203, thus firmware is upgraded.



VIII Oscilloscope Familiarization

1. Interfaces & buttons.

✪ Front view, left→right: **RUN/HOLD**(>||), **CALIBRATE** (■), **PRESET** (●), **SAVE WAVE**(▲)、**NAVIGATOR A**(—... +), **NAVIGATOR B**(<...>).

✪Left view, top→bottom:Wave output[WAVE OUT],analog channel B[CH_B], analog channel A[CH_A].

✪Right view, top→bottom: Digital channelC [CH_C], digital channelD [CH_D], USB port, power switch.



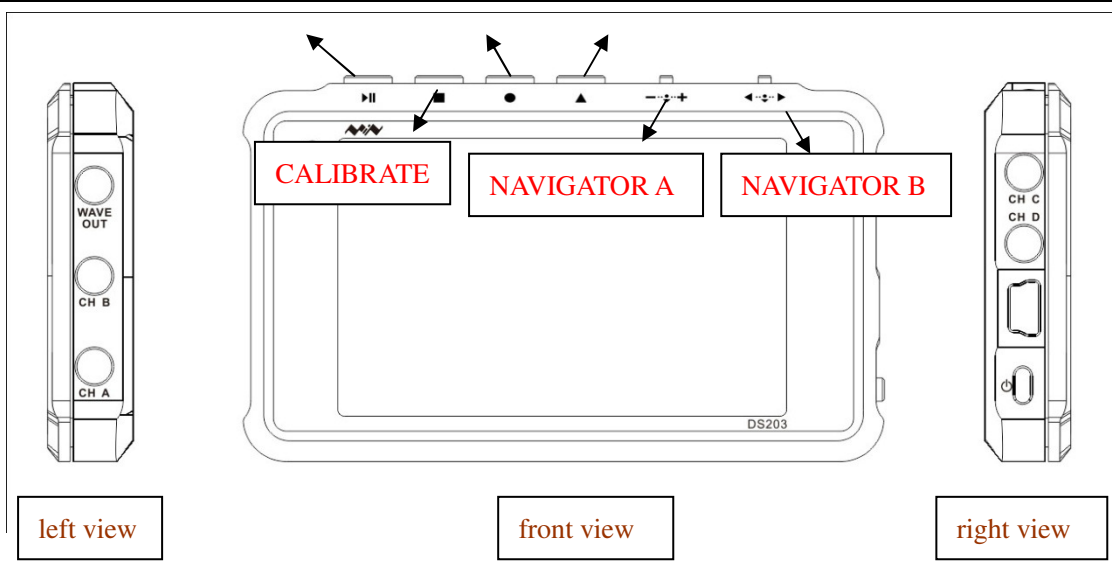

left view

front view

right view

2. Screen

The display is depicted below:

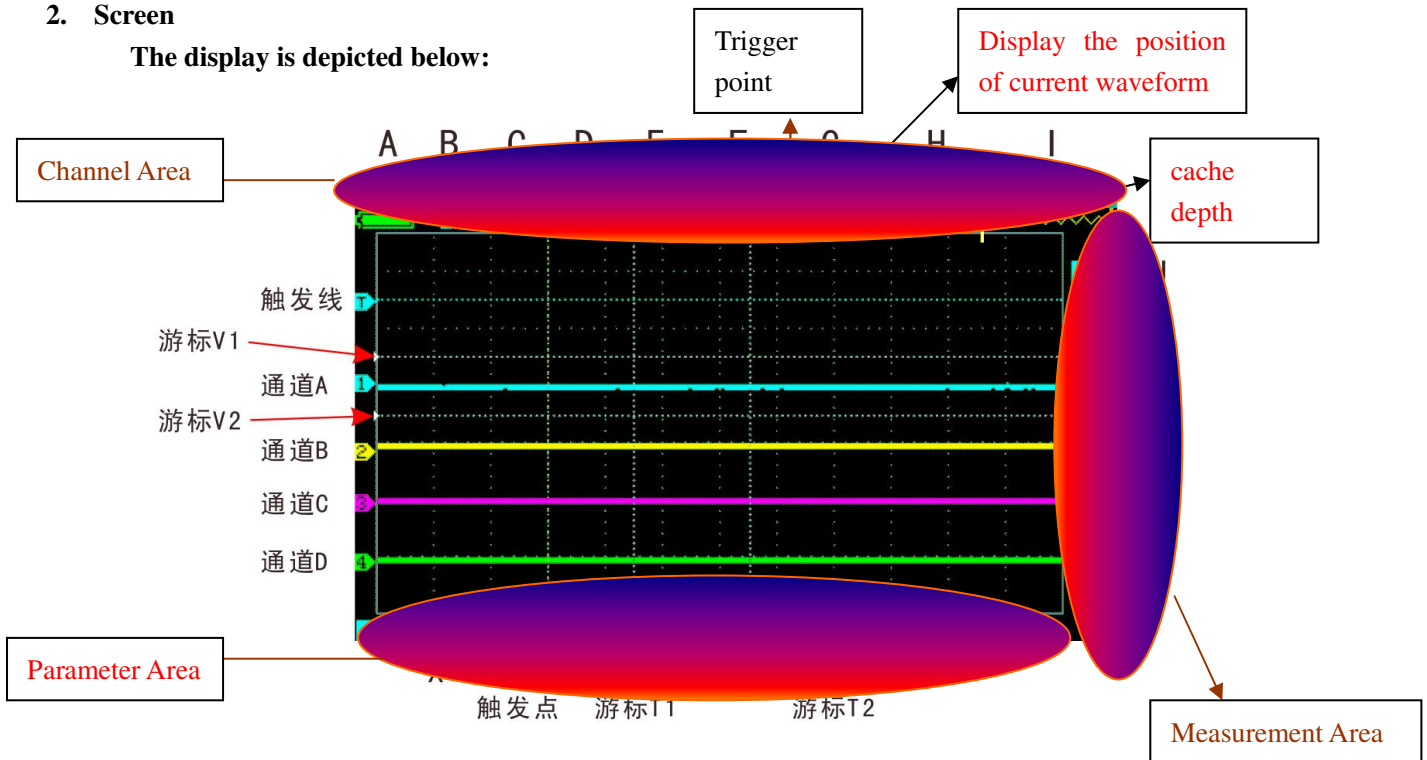

Horizontally A—I is channel area; vertically J—T is measurement area. You can move cursor within A—G by scrolling ($\leftarrow \dots \rightarrow$); change selection by scrolling ($- \dots +$); move cursor between upper & lower menus by pressing ($- \dots +$). When cursor is in G Position, press ($- \dots +$) to move it within G—I; and press (\blacktriangle) to move cursor between channel area & measurement area. Each menu has the same color as its corresponding channel: Channel A (blue), Channel B (yellow), Channel C (purple), Channel D (green), Common menu is orange.

U—X is parameter area, U position shows parameters for THR, V1 & V2 to choose; V position is the preferred parameter of (\bullet) button; W position is $\square T = T2 - T1$, X position is $\square V = V1 - V2$

2.1、Parameters

As in figure below, adjust G—I, output 1KHz from [WAVE OUT], input square waveform of 50% duty factor into CH_B, Short press (\bullet) to display current parameter. Annotations of parameters are shown in table below:

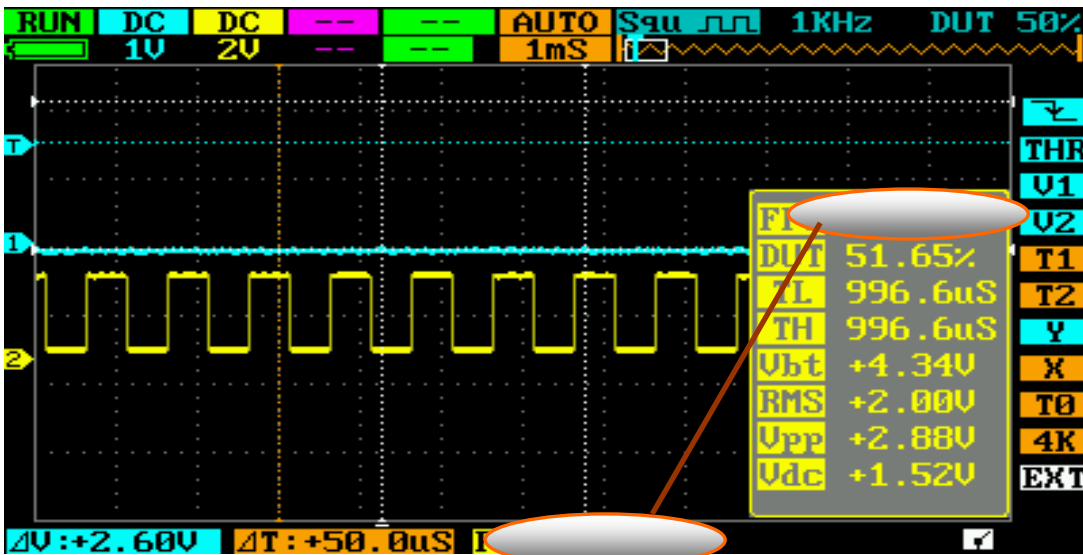

FPS	Frames Per Second
Vpp	Peak-to-Peak Voltage
Vdc	Direct Current Voltage
RMS	Average Value of Voltage
Max	Maximum Voltage
Min	Minimum Voltage
FRQ	Signal Frequency
CIR	Signal Cycle
DUT	Duty factor
TH	Monocycle High Level Time
TL	Monocycle Low Level Time
Vbt	Battery Voltage

There are 12 parameters; Short press(●) shows only 8 parameters; Press(●)longer and scroll (—...+)to select parameter, press (—...+) to choose color (channel), press (◀...▶)or choose EXT to exit; as below:

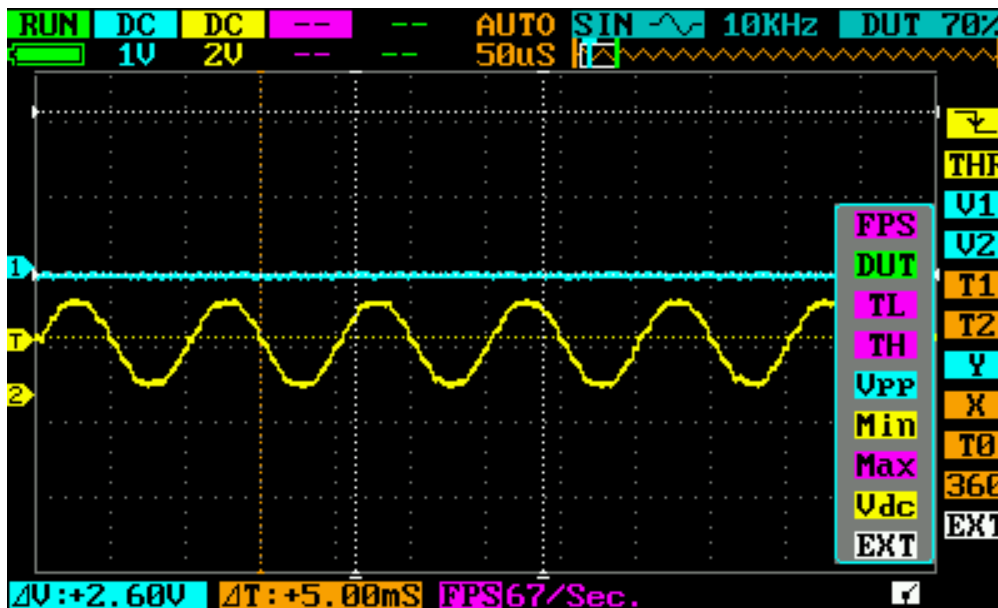

2.2. Functions of Channel Area

The table below shows the detailed introduction of the functions of menus in channel area :

Menu	Item	Function
A	RUN/HOLD	
B	AC/DC/--	(Channel A)AC coupling/DC coupling/hide voltage per grid
C	AC/DC/--	(Channel B)AC coupling/DC coupling/hide voltage per grid
D	DC/--	(Channel C) DC coupling/hide ---
E	CH_(D)/(A+B)/(A-B)/(C&D)/(CID)/ REC_A/ REC_B/ REC_C/ REC_D	thru CH_D: Input(A+B), waveforms of CH_A & CH_B sync (A-B): get subtraction of waveforms of CH_A & CHA_B (C&D): get and operation of CH_C & CH_D (CID): get or operation of CH_C & CH_D REC_A: reload the last waveform saved in CH_A Same for REC_B, REC_C & REC_D
F	AUTO/NORM/	(Trigger M)Auto/Norm/Sgl/slow scan/instant scan Unit per second
G	Squ/Sin/Tri/Saw (≈2.8Vpp)	(Waveform output)squ/sin/tri/sawtooth
H	(Squ)10Hz—8MHz (Sin/Tri/Saw) 10Hz—20KHz	<1MHz, stepping in 1-2-5mode
I	(Squ)50%—90% (±10%)	adjust duty factor

2.3、 Functions of Detection Area

The table below shows detailed illustrations of functions of menus in detection area:

Menu	Item	Function	Operating Instruction
------	------	----------	-----------------------

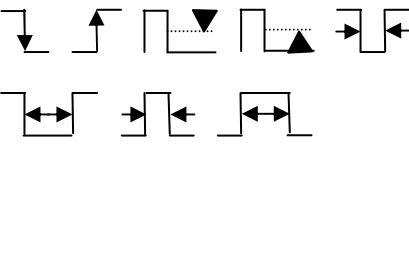
J		Trigger mode: falling edge trigger, rising edge trigger, (>, <) trigger, (<, >) negative pulse width, (<, >) positive pulse width	Scroll(—... +) to choose trigger mode, press (—... +) to choose channel (different colors)
K	THR	Trigger level	Scroll (—... +) to adjust trigger level (U position shows trigger level) , press (—... +) to choose channel (CH_A/CH_B/hide)
L	V1	Cursor V1: top limit of visible trigger level	Scroll (—... +) to select top limit of trigger level, and press (—... +) to choose channel(CH_A/CH_B/CH_C/CH_D/hide)
M	V2	Cursor V2: bottom limit of visible trigger level	Scroll (—... +) to adjust bottom limit of trigger level(in X position, shows $\Delta V=V1-V2$), press (—... +) to choose channel (CH_A/CH_B/CH_C/CH_D/hide)
N	T1	Time Maker T1	Scroll (—... +) to adjust time maker T1, and press (—... +) to hide time marker
O	T2	Time Marker T2	Scroll (—... +) to adjust time maker T2 (in W position shows $\Delta T=T1-T2$), press (—... +) to hide time marker T2.
P	Y	Horizontal Level of each channel	Scroll(—... +)to adjust horizontal level, press(—... +) to choose channel(CH_A/CH_B/CH_C/CH_D)
Q	X	Choose the window to display waveforms	Scroll(—... +) to choose waveforms of different positions to display on

			current window
R	T0	??????	???????
S	360-4K	Memory depth	Scroll (—... +) to choose memory depth
T	EXT/SAV	???????	???????

2.4、Menus

On screen, press (■) to access the menu, press again to exit. Detailed instructions are listed below:

Item (Up→Down)	Function	Operating Instruction
Save Param	Save current parameter settings	Press (—... +) to confirm, scroll (◀...▶) to the next menu
Save Dat	Save dat file to the built-in USB disk	Press (—... +) to confirm, scroll (—... +) to choose file no., scroll (◀...▶) to next menu
Save Buf	Save buf file (sample data in buffering area) to built-in USB disk	Press (—... +) to confirm, scroll (—... +) to choose file no., scroll (◀...▶) to next menu
Save Bmp	Save bmp file (waveform image) to the built-in USB disk.	Press (—... +) to confirm, scroll (—... +) to choose file no., scroll(◀...▶) to next menu.
Save Csv	Save csv file (export sampling data of buffering area) to built-in USB disk	Press (—... +) to confirm, scroll (—... +) to choose file no., scroll(◀...▶) to next menu.
Load Dat	Load dat file	Press (—... +) to confirm, scroll (—... +) to choose file no., scroll (◀...▶)to next menu.
Load Buf	Load buf file	Press (—... +) to confirm,

		scroll (—... +) to choose file no., scroll (◀...▶)to next menu.
BackLight	Adjust backlight brightness	Press (—... +) to confirm, scroll (—... +) to adjust backlight brightness, scroll (◀...▶) to next menu.
Buzzer	Adjust buzzer volume	Press (—... +) to confirm, scroll (—... +) to adjust buzzer volume, scroll (◀...▶) to next menu.
Standby	Choose screensaver	Press (—... +) to confirm, scroll (—... +) to choose file no., scroll (◀...▶) to next menu.
Calibrat	Instrument calibration (make sure CH_A is ground connected)	Press (—... +) to confirm, press (■) to calibrate.

IX Application Examples :

1. Example One : Measure simple signals

Observe one unknown signal in a circuit, measure & display the frequency & peak-to-peak value of the signal.

Please operate according to following steps:

- Connect the probe of CH_A/CH_B to the detection point of the circuit.
- Set CH(A)/CH(B) as AUTO mode, DC coupling, adjust the(horizontal) time calibration and (vertical) voltage calibration, make sure the signal displays clearly.
- Adjust THR value to make the display of signals stable.
- Press(●), analyze signal parameters, e.g.:Vpp(peak-to-peak voltage), RMS(average value of voltage),FRQ(frequency) and so on.

Take the following figure as an example :

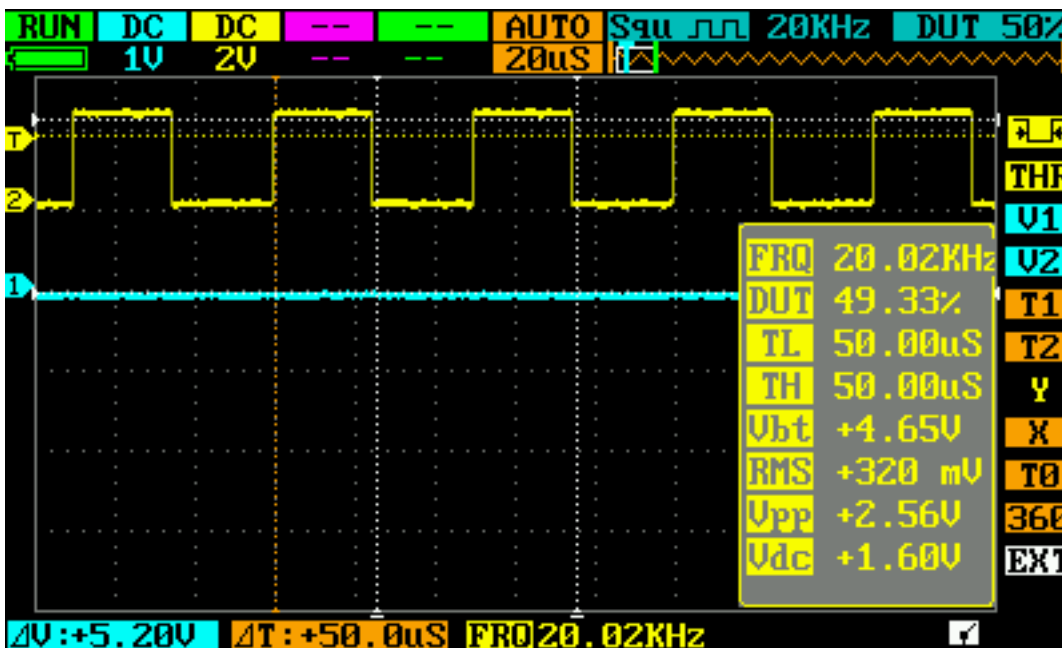

2. Example Two: Acquire a single signal

It's the superiority and feature of digital oscilloscope to easily acquire non-periodic signals like impulsion and **sentus**. To acquire a single signal, you need a priori knowledge of it to set trigger level & trigger edge. E.G. if impulsion is a TTL PWL logic signal, **trig level** should be set as 2V, trig edge as rising edge trig. If the signal is not stable, it's suggested to observe in a normal triggering mode to define trig level & trig edge.

Operation steps are as follows :

- Connect the probe of CH_B to detection point of the circuit.
- Set the triggering: set J as  (rising edge trig), F as SINGL(single trig), trig setting: DC coupling.
- Adjust horizontal time level and vertical scale to proper range.
- Adjust K position THR, adjust to proper trig level.
- Press (>||), wait for proper trig signal to appear. If a signal reaches preset trig level, sample & display it.

This function can catch occasional incidents very easily; e.g. a sudden **sentus** of high amplitude. Set the trig level a little higher than normal signal level, press (>||), and when the **sentus** occurs, the device will automatically trig & store the waveforms before & after the trig. It's depicted as the figure below to better observe the changes of waveforms before & after the trig.

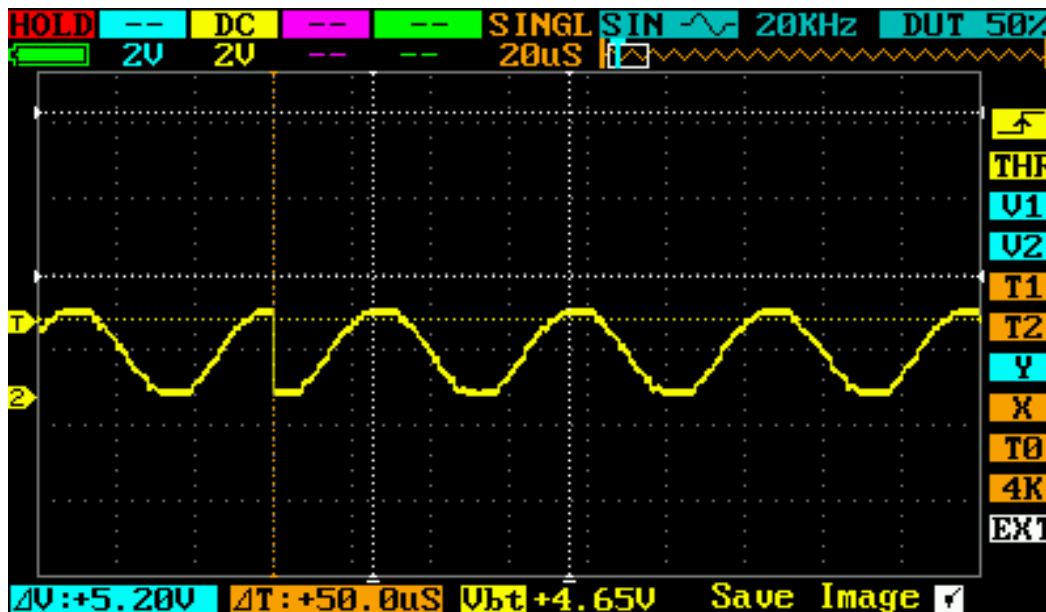

3. Example Three: Cursor measurements

A cursor can be used to measure the time and voltage of the waveform very quickly.

(1) Measure the cycle of the 3rd waveform from the signal source.

Please operate according to the following steps:

- Move cursor to N (T1),
- Scroll (—... +), put cursor T1 to the 3rd peak value of the signal.
- Move cursor to N position (T2).
- Scroll (—... +), put cursor T2 to the 4th peak value of the signal.

Then you'll get: $\Delta T = 14.0 \mu\text{s}$, i.e. cycle of the 3rd wave crest.

(2) Measure the peak-to-peak value of the signal source

Please operate according to the following steps:

- Move the cursor to L position (V1)
- Scroll (—... +), put cursor V1 to wave crest of the signal.
- Move cursor to M position (V2)
- Scroll (—... +), put cursor V2 to wave trough of the signal.

Then you'll get: $\Delta V = 168 \text{mV}$, i.e. peak-to-peak value of the signal

As shown in the following figure

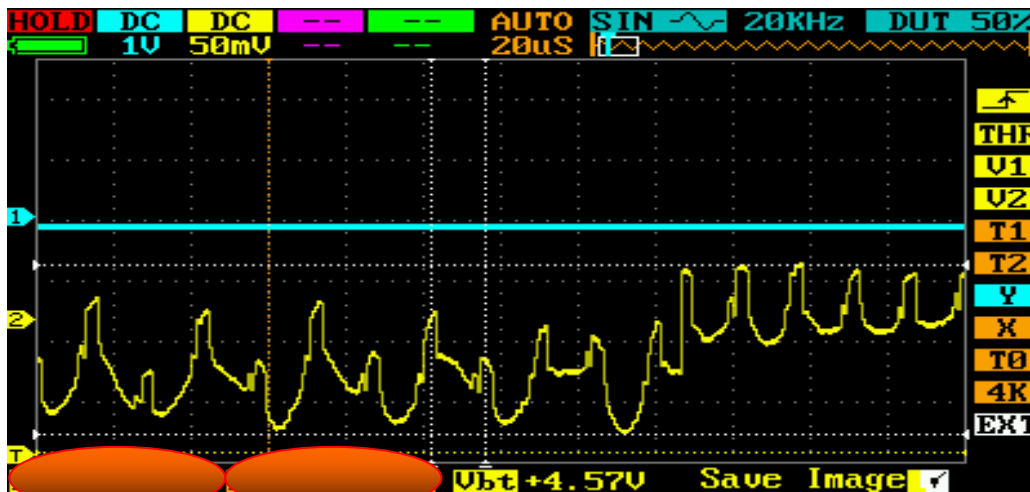

Vpp

Cycle

4. Example Four: Comparison of Waveforms

Module E(REC_A/ REC_B/ REC_C/ REC_D) can be used to compare standard signal & unknown signal.

Please operate according to following steps:

- Input standard signal to CH_A, press (■), choose Save Dat 01 to save waveform, as in Figure 4.1:
- Input unknown signal to CH_A, in E position choose REC_A, press (■), choose Load Dat, as Figure 4.2:
- Move P position Y to adjust horizontal level, to compare waveforms, as in Figure 4.3:

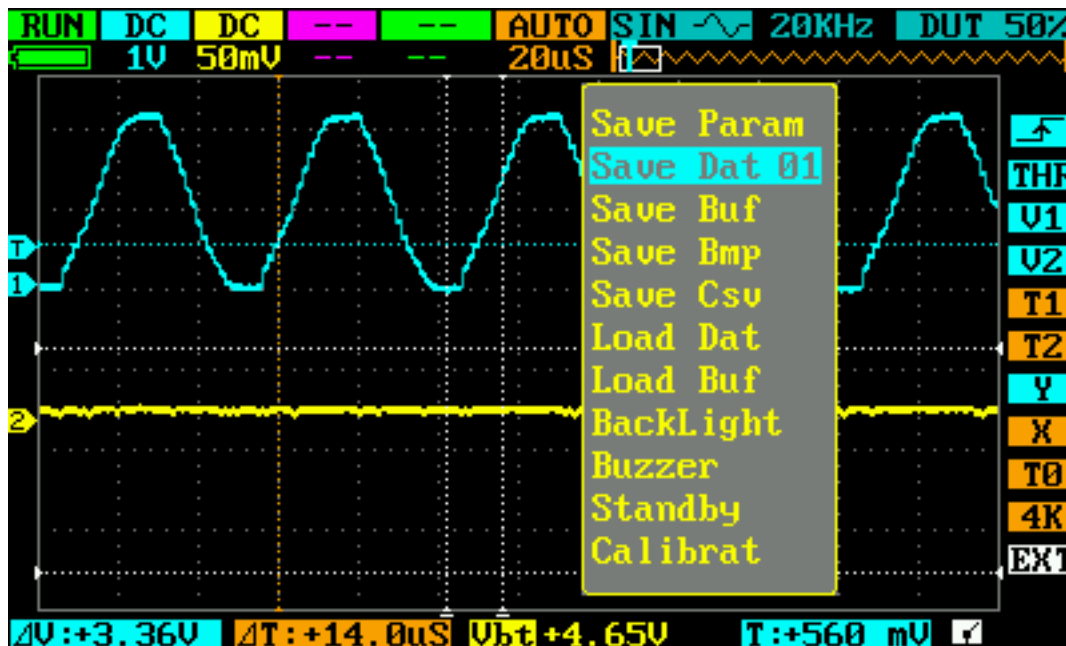

Figure 4.1

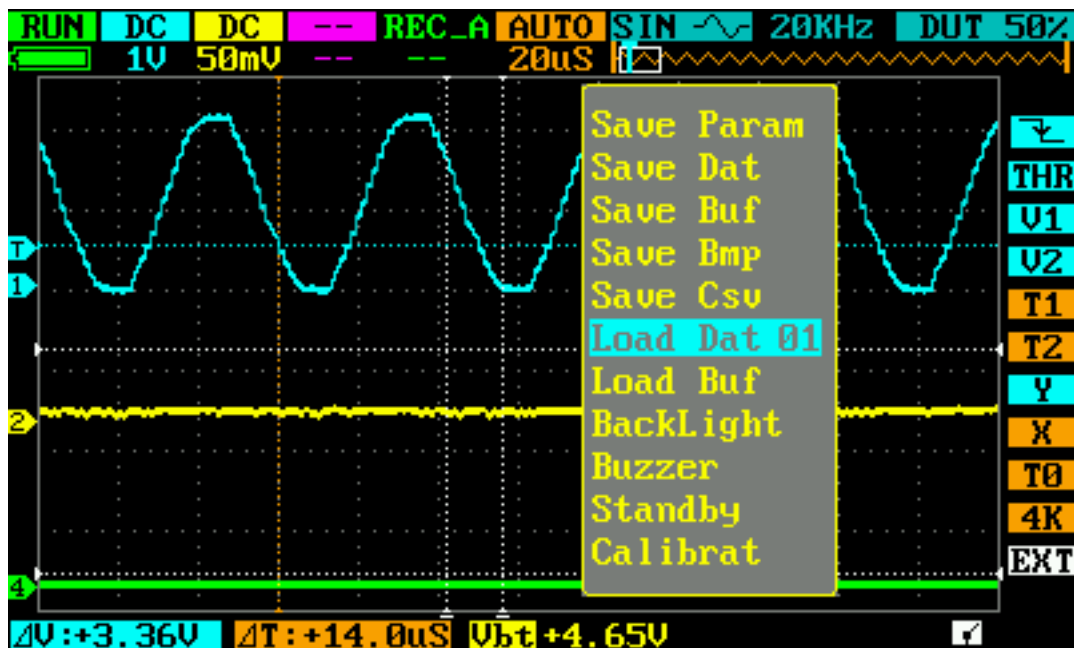

Figure 4.2

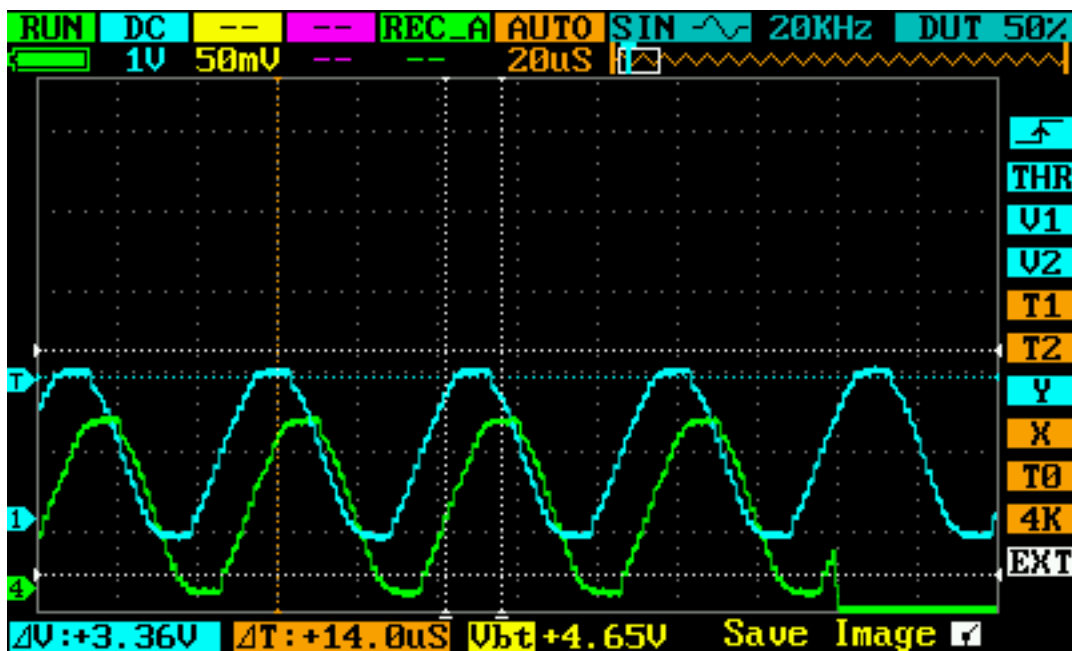

Figure 4.3

5. Example Five: Save waveform images

Sometimes waveform images need to be archived/analyzed on PC platform.

Please operate according to following steps:

➤With prerequisite of correct measurement of signal source, press (■), choose Save Bmp 01, scroll (←... +)

to choose file no., press (←... +) to confirm. The file (named IMAG001.BMP) will be saved to built-in USB disk; as in following figure.

➤To analyze waveform images, you only need to copy the images to your PC.

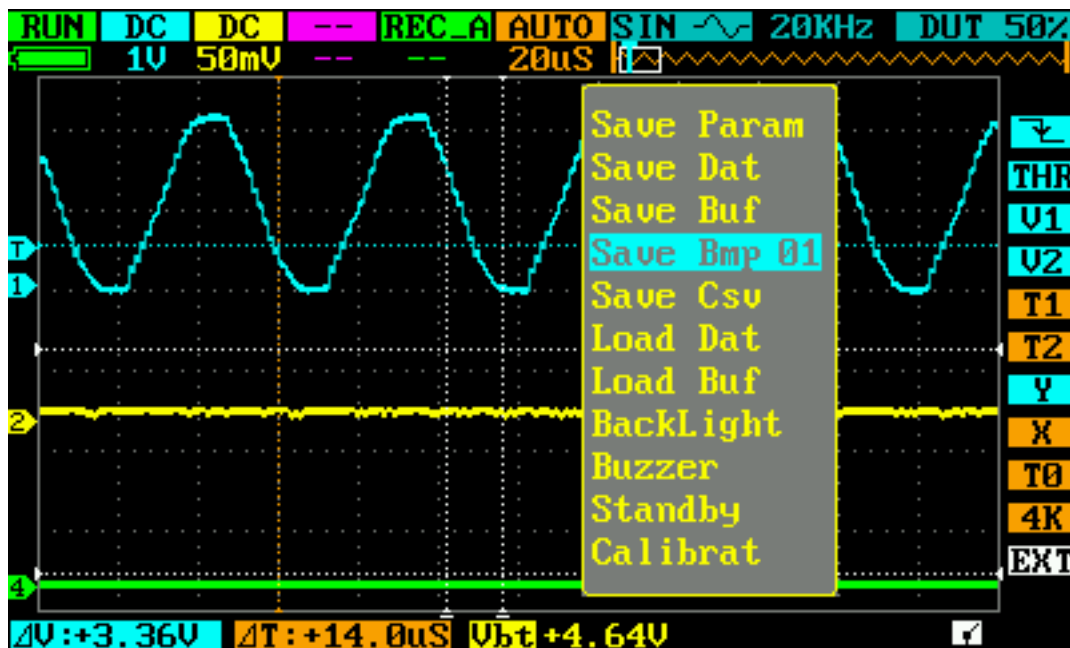

X Operation Tips

1. When measure high frequency signals, to enhance scan speed, it's suggested to lower buffer depth by adjusting S position, 360 points as a window, and adjust X in Q position to observe **the buffer waveforms in the memory.**
2. After access to the signal, choose AC coupling scale when need to observe noise and ripple waveform.
3. Use cursor V1 & V2 to measure two random points for voltage difference.
4. Use cursor T1 & T2 to measure two random points for time differ