

Switching Structure Based on the Micro Strip Line is Used to Combine High Performance and Cost-effectiveness

- Isolation characteristics of 65 dB or better at 900 MHz
- Effective insertion loss characteristics of 0.2 dB or better at 900 MHz (half the loss of earlier models)
- Plastic seal construction provides excellent environmental resistance.
- Improved shock-resistance (double the resistance of earlier models)



Ordering Information

Class	Sealing Contact configuration	Plastic seal	
		Coil rated voltage	Model
Basic type	SPDT	4.5 VDC	G6Y-1
		5 VDC	
		9 VDC	
		12 VDC	
		24 VDC	

Model Number Legend

G6Y-□
1

1. Number of contact poles
1: Single pole (SPDT contact)

Basic Specifications

- Contact Mechanism: Double-braking twin contact
- Contact Material: Gold alloy
- Sealing: Plastic seal
- Terminal Configuration: Printed circuit board terminal configuration

Application Examples

Signal Switching in Various Communications Equipment

- Wired Communications: Cable TV, caption systems, and video response systems (VRS)
- Wireless Communications: Transceivers, ham radio, car telephones, high-level TV, fax machines, satellite broadcasting, text multiplex broadcasting, and pay TV
- Public Equipment: VCRs, TVs, video disk players, and TV games
- Industrial Equipment: Measuring equipment, test equipment, and multiplex transmission devices

Specifications

■ Ratings

Operational Coil

Class	Item	Rated voltage (V)	Rated current (mA)	Coil resistance (Ω)	Operating voltage (V)	Release voltage (V)	Max. allowed voltage (V)	Power consumption (mW)
Basic type	DC	4.5	44.4	101	75% max.	10% min.	150% (at 23°C)	Approx. 200
		5	40.0	125				
		9	22.2	405				
		12	16.7	720				
		24	8.3	2,880				

Note: The rated current and coil resistance are measured at a coil temperature of 23°C with a tolerance of $\pm 10\%$.

The operating characteristics are measured at a coil temperature of 23°C.

The "Max. allowed voltage" is the maximum voltage that can be applied to the relay coil. It is not the maximum voltage that can be applied continuously.

Switch (Contacts)

Load	Resistive load
Rated load	0.01 A at 30 VAC 0.01 A at 30 VDC 900 MHz, 1 W (see note)
Rated carry current	0.5 A
Max. contact voltage	30 VAC 30 VDC
Max. contact current	0.5 A
Max. switching capacity (reference value)	AC10VA DC10W

Note: This value is for a load with V.SWR ≤ 1.2 .

High-frequency Characteristics

Item	250 MHz	900 MHz	2.5 GHz
Isolation	80 dB min.	65 dB min.	30 dB min.
Insertion loss	0.5 dB max.	0.5 dB max.	---
V.SWR	1.5 max.	1.5 max.	---
Max. carry power	10 W		---
Max. switching power	10 W (see note 1)		---

Note: The impedance of the measuring system is 50 Ω .

The table above shows preliminary values.

Note: 1. This value is for a load with V.SWR ≤ 1.2 .

■ Characteristics

Contact resistance (see note 1)	100 m Ω max.
Operating time	10 ms max. (approx. 5 ms)
Release time	5 ms max. (approx. 1 ms)
Insulation resistance (see note 2)	100 M Ω min.
Dielectric strength	1,000 VAC, 50/60 Hz for 1 min between coil and contacts
	500 VAC, 50/60 Hz for 1 min between contacts of same polarity
	500 VAC, 50/60 Hz for 1 min between coil and ground and between contacts and ground
Vibration resistance	Destruction: 10 Hz to 55 Hz, 1.5 mm double amplitude Malfunction: 10 Hz to 55 Hz, 1.5 mm double amplitude
Shock resistance	Destruction: 1,000 m/s ² (approx. 100G) Malfunction: 500 m/s ² (approx. 50G)
Life expectancy	Mechanical: 1,000,000 operations min. (at 1,800 operations/hr.) Electrical: 300,000 operations min. (under rated load at 1,800 operations/hr.)
Error rate P level (reference value (see note 3))	10 mVDC, 10 μ A
Ambient temperature	Operating: -40°C to 70°C (with no icing) Storage: -40°C to 70°C (with no icing)
Ambient humidity	Operating: 35 to 85% Storage: 35 to 85%
Weight	Approx. 5 g

Note: The table above shows preliminary values.

1. Measurement Conditions: 5 VDC, 100 mA, voltage drop method
2. Measurement Conditions: Measured at the same points as the dielectric strength using a 500-VDC ohmmeter.
3. This value is for a switching frequency of 120 operations/minute.

Engineering Data

Ambient Temperature vs. Max. Allowed Voltage

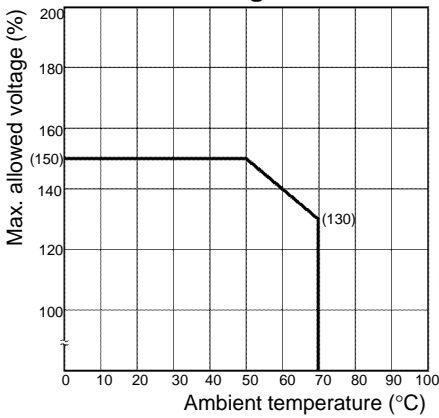

Note: The "Max. allowed voltage" is the maximum voltage that can be applied to the relay coil.

Malfunctioning Shock

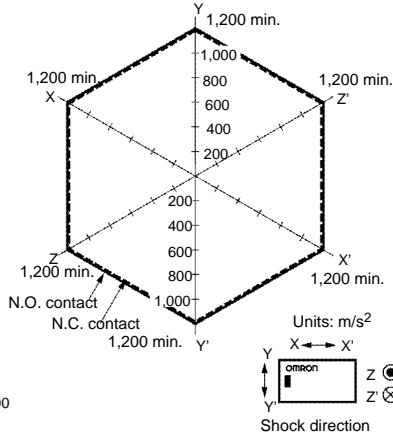

Quantity Tested: 10 Units

Test Method: Shock was applied 3 times in each direction with and without excitation and the level at which the shock caused malfunction was measured.

Rating: 500 m/s^2 (approx. 50G)

Contact Reliability Test (See Note)

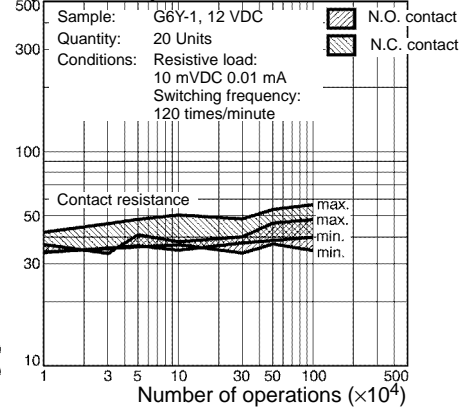

Note: Ambient temperature of 23°C

High-frequency Characteristics

Measurement Conditions

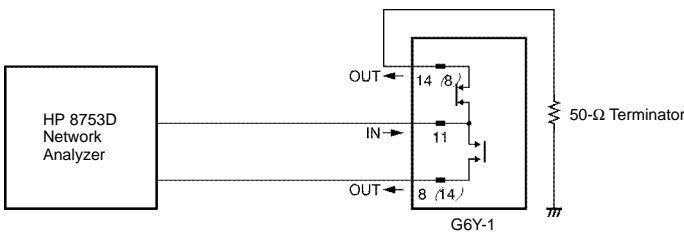

Terminals which were not being measured were terminated with 50 Ω .

Note: The high-frequency characteristics data were measured using a dedicated circuit board and actual values will vary depending on the usage conditions. Check the characteristics of the actual equipment being used.

Isolation Characteristics (Average Values)

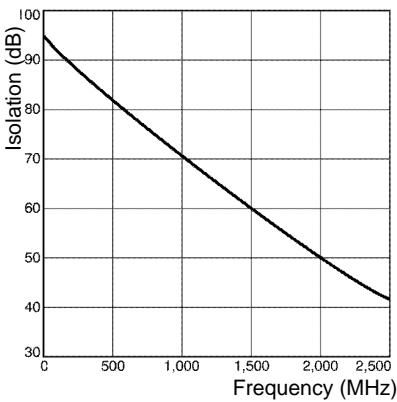

Insertion Loss Characteristics (Average Values)

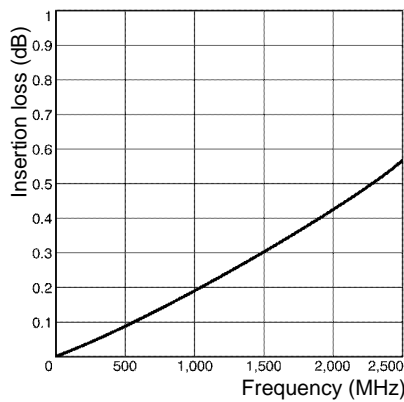

V.SWR, Return Loss Characteristics (Average Values)

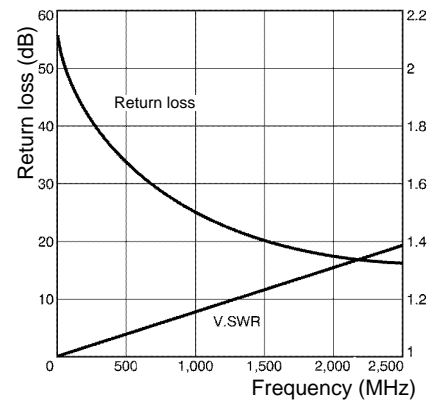

Operating/Release Time Distribution (See Note)

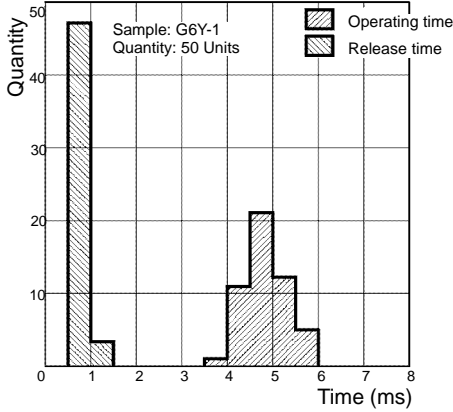

Bounce Time Distribution (See Note)

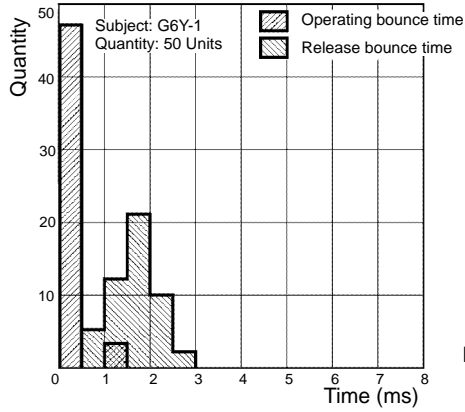

Note: Ambient temperature: 23°C

Dimensions

Note: All units are in millimeters unless otherwise indicated.

G6Y-1

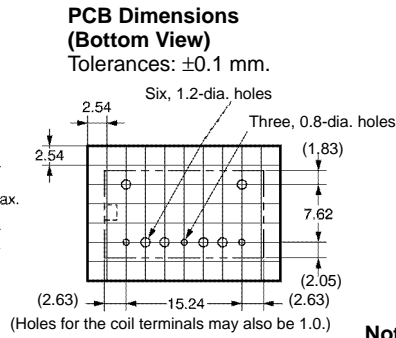
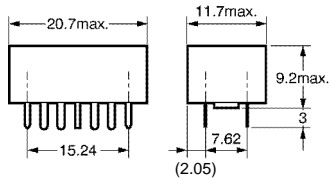
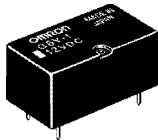

Terminal Arrangement/ Internal Connections (Bottom View)

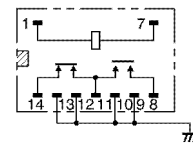

(There is no polarity to the coil.)

Note: The shaded and unshaded parts indicate the product's directional marks.

Precautions

Refer to the *PCB Relays Catalog (X33)* for information on general precautions. Be sure to read these precautions before using the G6Y Relay.

■ Correct Use

Airtightness when cleaning will last 1 minute at 70°C. Complete cleaning within these conditions.

Micro Strip Line Design

- It is advantageous to use the Micro Strip Line in high-frequency transmission circuits because a low-loss transmission can be constructed with this method. By etching the dielectric base which has copper foil attached to both sides, the Micro Strip Line will have a concentrated electric field between the lines and ground as shown in the following diagram.

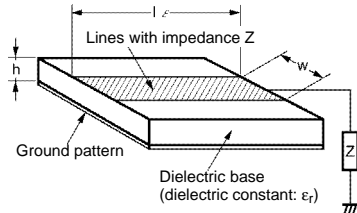

- The characteristic impedance of the lines Z_0 is determined by the kind of base (dielectric constant), the base's thickness, and the width of the lines, as expressed in the following equation.

$$Z_0 = \frac{377}{\sqrt{\epsilon_r} \frac{W}{H} \left\{ 1 + \frac{2H}{\pi W} \left[1 + \ln \frac{\pi W}{H} \right] \right\}}$$

W: Line width

ϵ_r : Effective dielectric constant

H: Dielectric base thickness

The copper foil thickness must be less than H.

- The following graph shows this relationship.

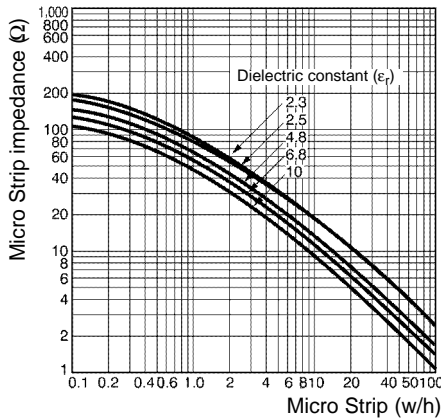

- For example, when creating 50-Ω lines using a glass epoxy base with a thickness of 1.6 mm, the above graph will yield a w/h ratio of 1.7 for a dielectric constant of 4.8. Since the base thickness is 1.6 mm, the width will be $h \times 1.7 \approx 2.7$ mm. The thickness of the copper foil "t" is ignored in this design method, but it must be considered because large errors will occur in extreme cases such as a foil thickness of $t \approx w$. Furthermore, with the Micro Strip Line design, the lines are too short for the G6Y's intended frequency bandwidths, so we can ignore conductive losses and the line's attenuation constant.
- The spacing of the Strip Lines and ground pattern should be comparable to the width of the Strip Lines.
- Design the pattern with the shortest possible distances. Excessive distances will adversely effect the high-frequency characteristics.
- Spread the ground patterns as widely as possible so that potential differences are unlikely to develop between the ground patterns.
- To avoid potential short-circuits, do not place the pattern's leads near the point where the bottom of the Relay attaches to the board.

Bending the Micro Strip Line

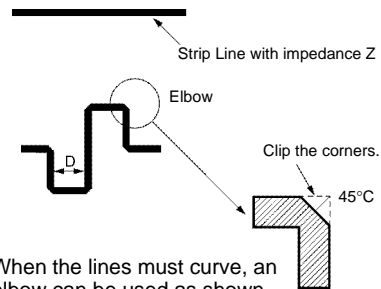

When the lines must curve, an elbow can be used as shown in the diagram. A distance (D) between the lines of approximately twice the line width is sufficient.

Examples of Mounting Designs

Since this example emphasizes reducing mounting costs, expensive mounting methods such as through-hole boards are not shown. If such methods are to be used, the characteristics must be studied carefully using the actual board configuration.

Using a Double-sided Paper Epoxy Board

When double-sided paper epoxy boards are used, the dielectric constant will be approximately the same as that of glass epoxy boards ($\epsilon_r=4.8$).

The width of the Strip Lines for a board with $t=1.6$ mm is 2.7 mm for 50 Ω and 1.3 mm for 75 Ω . For a board with $t=1.0$ mm the width is 1.7 mm for 50 Ω and 0.8 mm for 75 Ω .

The following diagram shows an example pattern and the Micro Strip Lines connected to the contact terminals are formed with pattern widths derived from the description above. The width between the Micro Strip Lines and ground patterns are comparable to the Micro Strip Line width.

There are jumpers between the upper and lower patterns at the points marked with Xs in the diagram. Improved characteristics can be obtained with more jumper locations. This method yields isolation characteristics of 65 dB to 75 dB at 500 MHz and 50 dB at 900 MHz.

At this point in the diagram the component side is the entire ground pattern side, but set aside approximately 2.0 mm \times 2.0 mm of the pattern for the contact terminals and coil terminals.

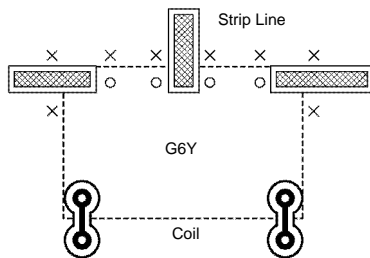

Using a Single-sided Board

When a single-sided board is used, isolation characteristics of only 60 dB to 70 dB at 200 MHz can be obtained. When high frequency bands are to be used with a single-sided board, a metal plate can be placed between the base and Relay and connected to the ground pattern.

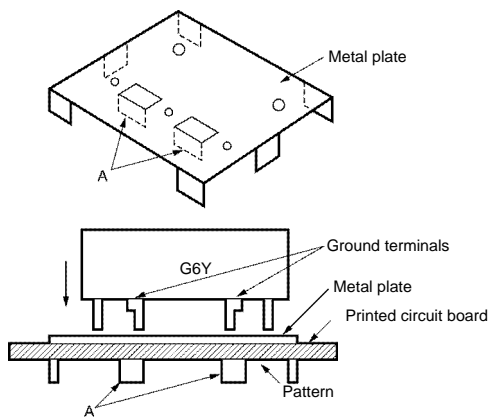

With this method a metal plate is placed between the Relay and base and connected to the pattern, as shown in the above diagram. The important point here is that 3 locations (the G6Y's ground terminal, the metal plate's bent tabs (A), and the ground pattern) are soldered together at the same time. This method combines an inexpensive single-sided board and inexpensive metal plate to yield the same characteristics as a double-sided board and good characteristics are obtained by grounding the G6Y's ground terminal and metal plate in the same place.

The metal plate must be attached to the base as described here. From this point, the methods used for Strip Line design are the same as for the double-sided board.

Mounting Precautions

Be sure to securely attach the Relay's base surface to the board during installation. The isolation characteristics will be affected if the Relay lifts off the board.

As shown in the enlarged illustration of the cross-section of part A, the G6Y is designed to ensure better high-frequency characteristics if the stand-off part of the G6Y is in contact with the ground pattern of the PCB. Therefore, the ground terminal and stand-off part are electrically connected internally.

Should the through hole electrically connected to the contact terminal come in contact with the stand-off part, the contact will be short-circuited with the ground, which may cause in an accident.

As a preventive measure, keep at least a distance of 0.3 mm between the stand-off part and the through hole or land.

For example, if the terminal hole on the PCB is 1 mm in diameter and the length B shown in the illustration is 1.4 mm, a distance of 0.3 mm or more will be provided between the through hole and stand-off part.

PCB Mounting

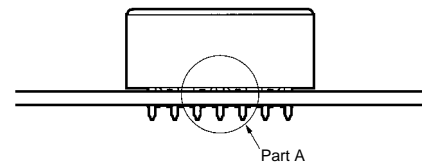

Cross-section of Part A

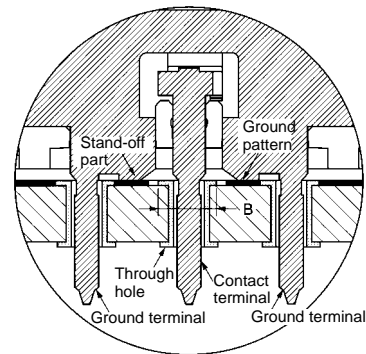

■ Notes

■ Notes

ALL DIMENSIONS SHOWN ARE IN MILLIMETERS.

To convert millimeters into inches, multiply by 0.03937. To convert grams into ounces, multiply by 0.03527.

Cat. No. K104-E1-1A **In the interest of product improvement, specifications are subject to change without notice.**

OMRON Corporation

C&C Components Division H.Q.
Sales & Marketing Division
Telecom Business Department
28th Fl., Crystal Tower Bldg.,
1-2-27, Shiromi, Chuo-ku,
Osaka 540-6028 Japan
Phone: (81)6-949-6115 Fax: (81)6-949-6114

Printed in Japan
0998-1.5M (0498) Ⓐ