



LA4631 — Monolithic Linear IC

5 W Two-Channel AF Power Amplifier for Audio Applications

Overview

The LA4631 (5 W × 2 channels) is a single-ended power IC that has a pin arrangement similar to the LA4632 BTL power IC (10 W × 2 channels). The LA4631's pin compatibility makes it possible to share a common printed circuit board among a series of end products differentiated by power rank. (Note that the LA4632 is provided in an SIP-12H package, and that it is necessary to provide a hole for the LA4631 pin 13 if the same printed circuit board is to be shared. Note also that certain external components differ.)

Functions and Applications

- Two-channel power amplifier for audio applications

Absolute Maximum Ratings at Ta = 25°C

Parameter	Symbol	Conditions	Rated value	Unit
Maximum supply voltage	V _{CC} max	With no input signal	24	V
Maximum output current	I _O peak	Per channel	2	A
Allowable power dissipation	P _d max	With an infinitely large heat sink	15	W
Maximum junction temperature	T _j max		150	°C
Operating temperature	T _{opr}		-20 to +75	°C
Storage temperature	T _{stg}		-40 to +150	°C

Operating Conditions at Ta = 25°C

Parameter	Symbol	Conditions	Rated value	Unit
Recommended supply voltage	V _{CC}		14	V
Recommended load resistance range	R _L op		4	Ω
Allowable operating supply voltage range	V _{CC} op		5.5 to 22	V

*: V_{CC}, R_L, and the output level must be set for the size of the heat sink used so that the P_d max range is not exceeded.

- Any and all SANYO products described or contained herein do not have specifications that can handle applications that require extremely high levels of reliability, such as life-support systems, aircraft's control systems, or other applications whose failure can be reasonably expected to result in serious physical and/or material damage. Consult with your SANYO representative nearest you before using any SANYO products described or contained herein in such applications.
- SANYO assumes no responsibility for equipment failures that result from using products at values that exceed, even momentarily, rated values (such as maximum ratings, operating condition ranges, or other parameters) listed in products specifications of any and all SANYO products described or contained herein.

LA4631

Operating Characteristics at $T_a = 25^\circ\text{C}$, $V_{CC} = 14\text{ V}$, $R_L = 4\ \Omega$, $f = 1\text{ kHz}$, $R_g = 600\ \Omega$

Parameter	Symbol	Conditions	Ratings			Unit
			min	typ	max	
Standby current	I_{st}	$V_{STB} = 0\text{ V}$		1	10	μA
Quiescent current drain	I_{CCO}	$R_g = 0$, $V_{STB} = 5\text{ V}$	18	35	80	mA
Standby pin applied voltage	V_{st}	The pin 5 voltage such that the amplifier is on	1.5		5	V
Output power	P_O	$\text{THD} = 10\%$	4	5		W
Total harmonic distortion	THD	$V_O = 1\text{ W}$		0.15	0.4	$\%$
Voltage gain	VG	$V_O = 0\text{ dBm}$	33	35	37	dB
Output noise voltage (rms)	V_{NO}	$R_g = 0$, $\text{BPF} = 20\text{ Hz to } 20\text{ kHz}$		0.05	0.25	mVrms
Supply voltage rejection ratio	SVRR	$R_g = 0$, $f_R = 100\text{ Hz}$, $V_{CCR} = 0\text{ dBm}$	50	60		dB
Channel separation	CH. Sep	$R_g = 10\text{ k}\Omega$, $V_O = 0\text{ dBm}$	45	55		dB
Input resistance	R_i		20	30	40	$\text{k}\Omega$

Package Dimensions

unit : mm

3236

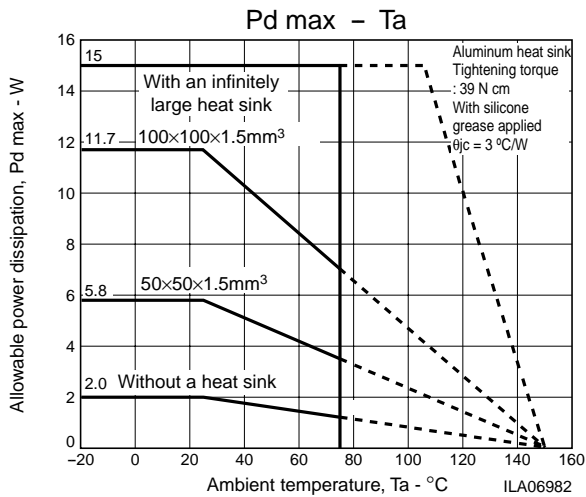
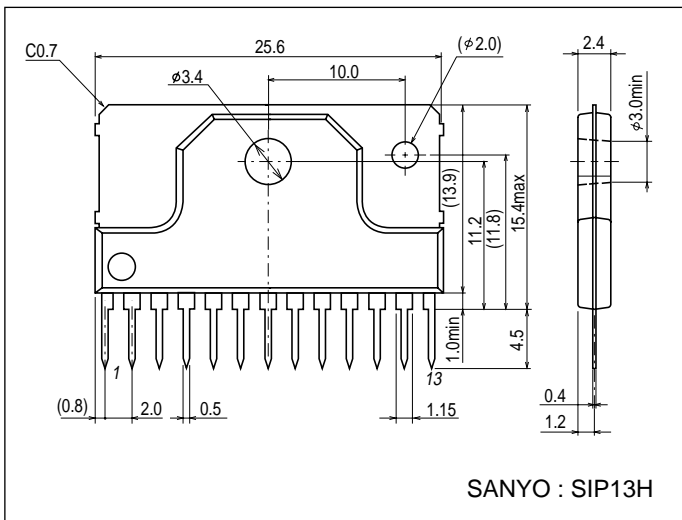

Application Circuit Example

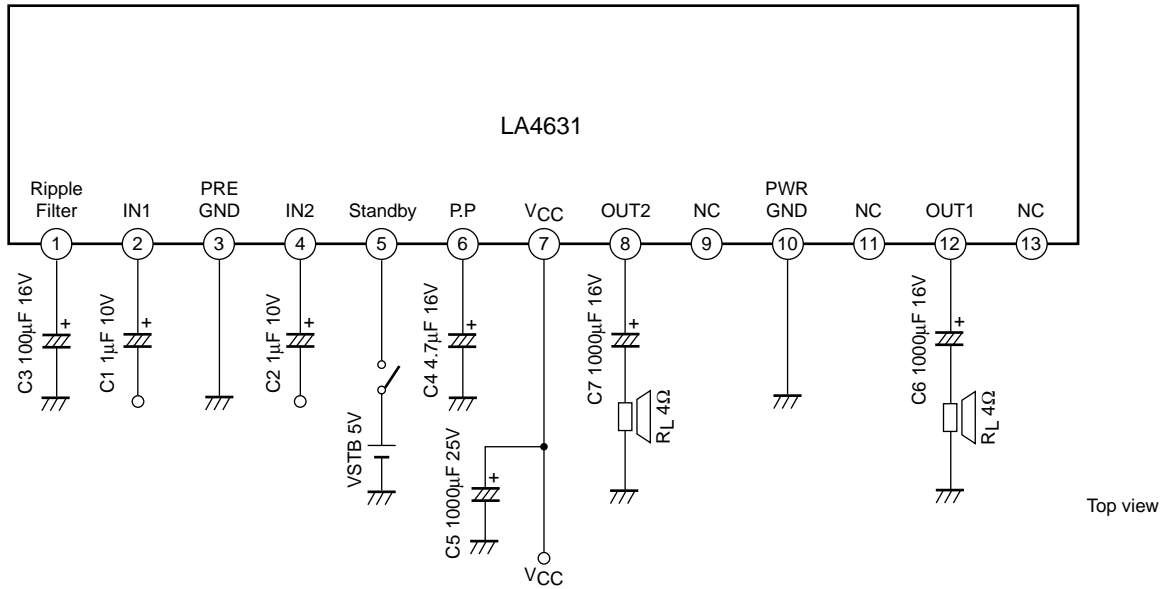

• Caution

Although the LA4631 is basically pin compatible with the LA4632, there are certain differences in the external components and the way the devices are used.

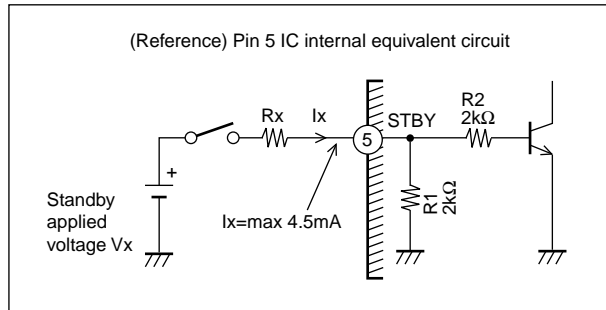

- The amplifier can be turned on or off by controlling the high/low state of pin 5.
- The amplifier is turned on by applying a voltage of 1.5 V or higher or an influx current of 800 µA or higher. (If a 5 V level is applied directly to pin 5, the pin 5 influx current will be about 4.5 mA.)
- If a voltage, V_x, that exceeds 5 V will be applied, insert a current limiter resistor (R_x) so that the influx current does not exceed 4.5 mA. (See the formula below.)

$$R_x = (V_x - 5 \text{ V}) / 4.5 \text{ mA}$$

- When pin 5 is controlled by a microcontroller, to set up a pin 5 influx current (I_x) optimal for the drive capacity of the microcontroller, calculate R_x from the following formula as a first approximation and measure the influx current to verify that level.

$$R_x = (V_x / I_x) - R_1 (2 \text{ k}\Omega)$$

*: When a voltage is applied to the standby pin (pin 5), refer to the above and insert a resistor (R_x) to limit the influx current if required.

Block Diagram

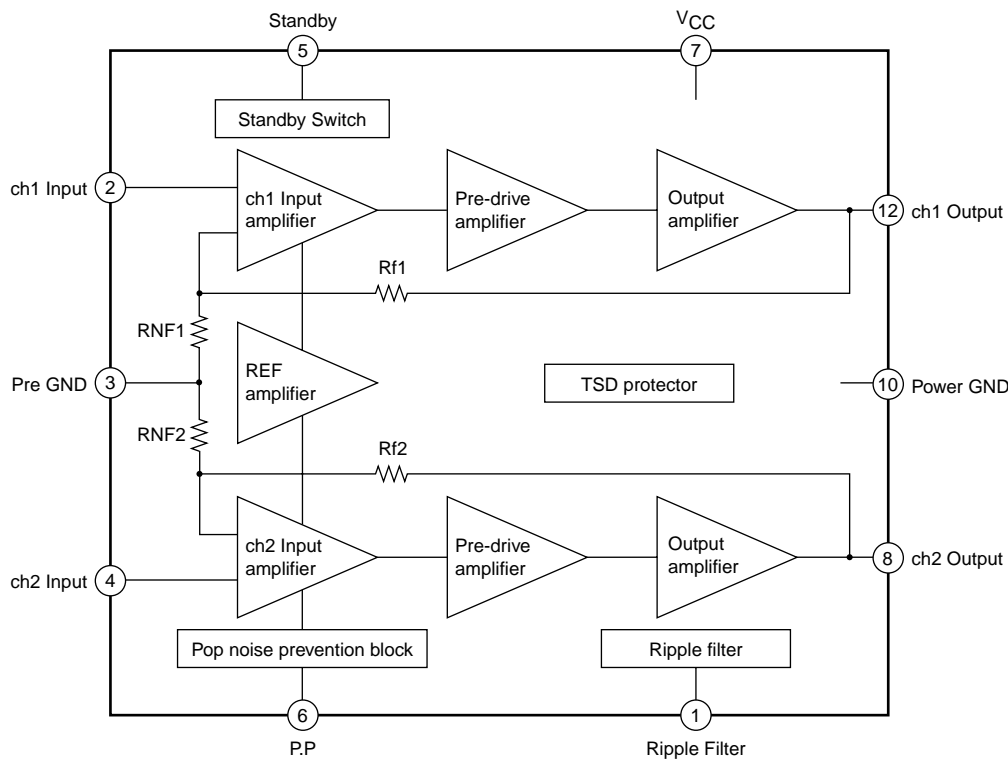

External Components and Usage Notes

- C1, C2: These are input coupling capacitors; we recommend a value of 1 μF or lower. The LA4631 input pin potential is about 1.4 V, and the polarity must be considered due to the DC potential of the circuits connected to the LA4631 front end. The amplifier's startup time (the time from the point power is first applied until the point an output is generated) will change proportionally with the values of these input capacitors. (When 1 μF capacitors are used, the startup time will be about 0.2 seconds.)
- C3: This capacitor is used as a ripple filter. We recommend a value of 100 μF . Amplifier impulse noise when turned off (when the standby pin goes low) may be made worse if a value under 100 μF is used. The pin 1 voltage is about $1/2 V_{CC}$. A DC mute function can be applied if pin 1 is connected to ground through a 300 to 500 Ω resistor. Note that the muting activation voltage will be too low if a resistor value of 750 Ω or higher is used.
- C4: This is an impulse noise prevention capacitor. The recommended value is 4.7 μF . If a value of 2.2 μF or lower is used for C4, impulse noise when the amplifier is turned off (when the standby pin goes low) may be made worse. Also, if a value of 10 μF or higher is used, an "incomplete muting" phenomenon may occur when the amplifier is turned off (when the standby pin goes low).
- C5: Power supply capacitor. This capacitor should be located as close as possible to the IC (to minimize increases in the power supply line impedance) to achieve stable amplifier operation.
- C6, C7: Output capacitors. These capacitors influence the amplifiers low band frequency characteristics. ($f_c = 1/2 \pi C_{out} \times R_L$)
 f_c = low band cutoff frequency, C_{out} = C6, C7

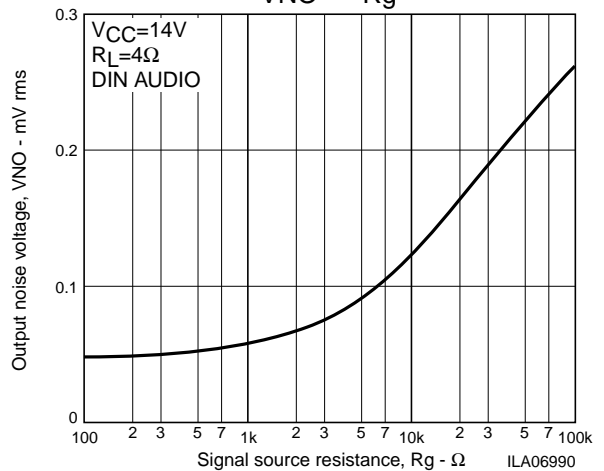
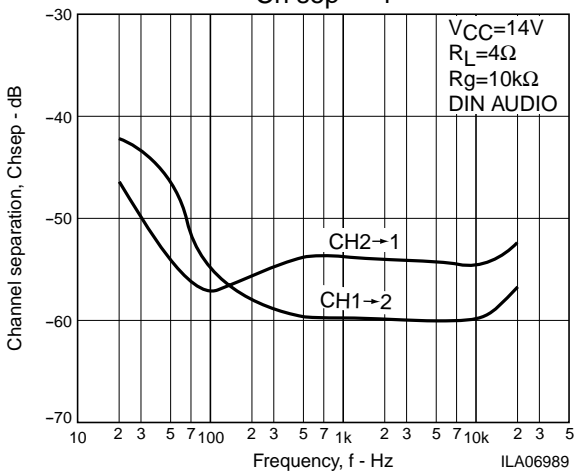
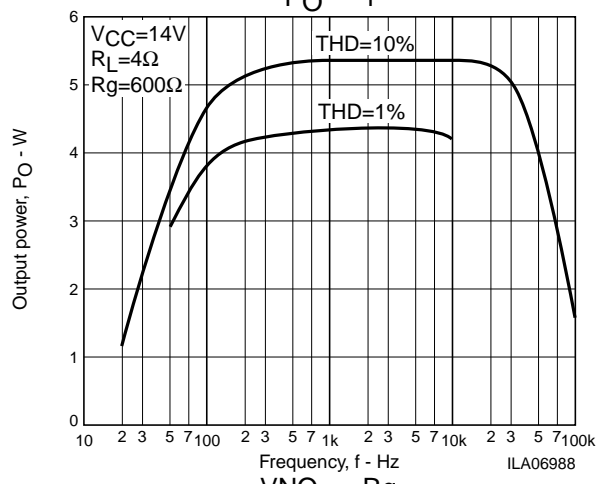
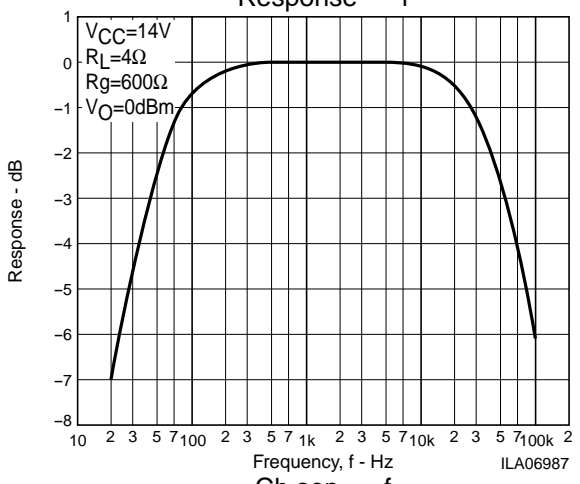
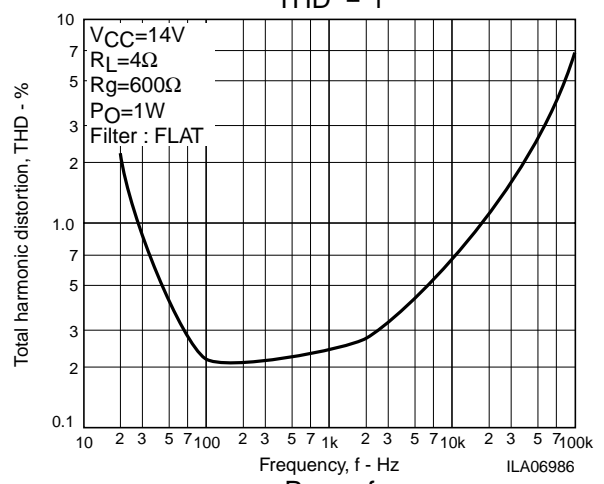
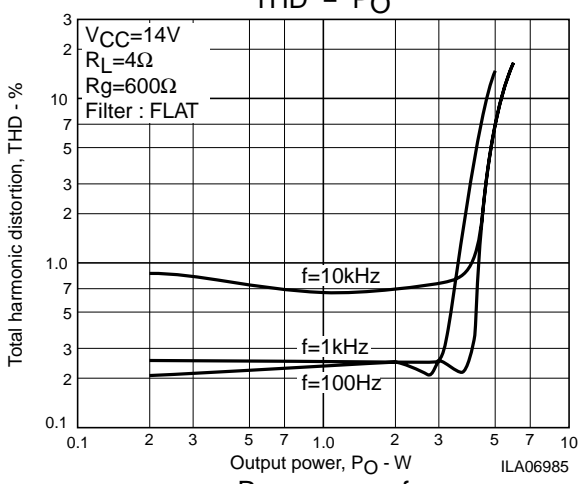
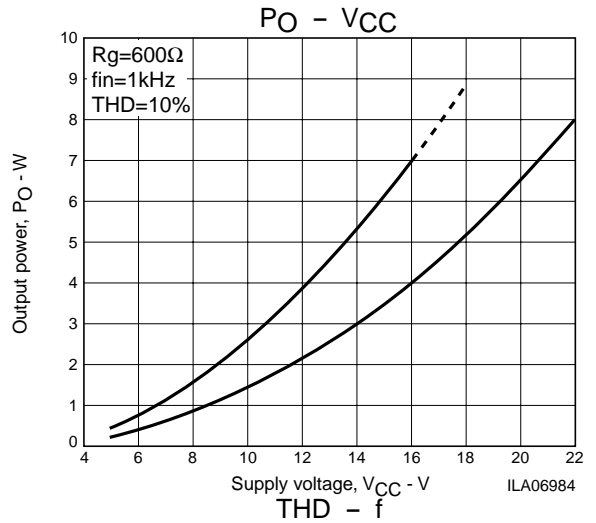
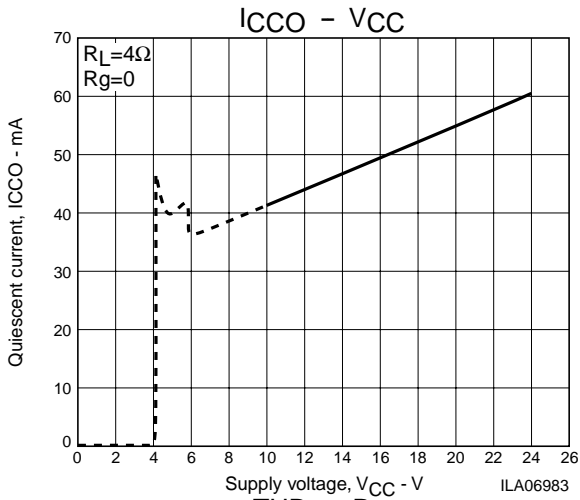

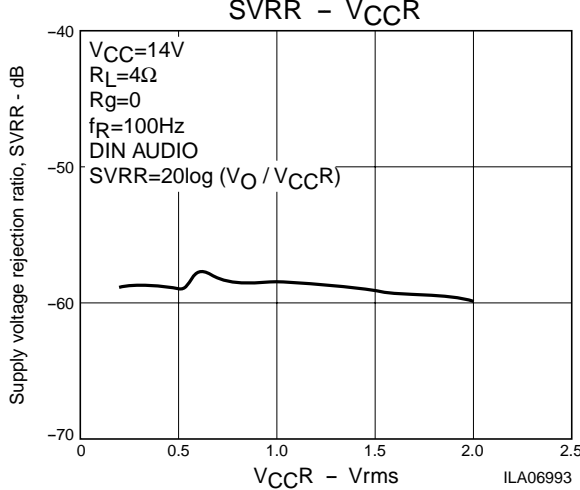
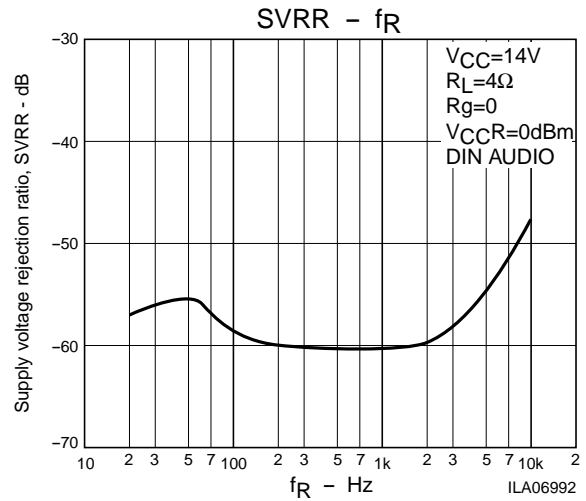
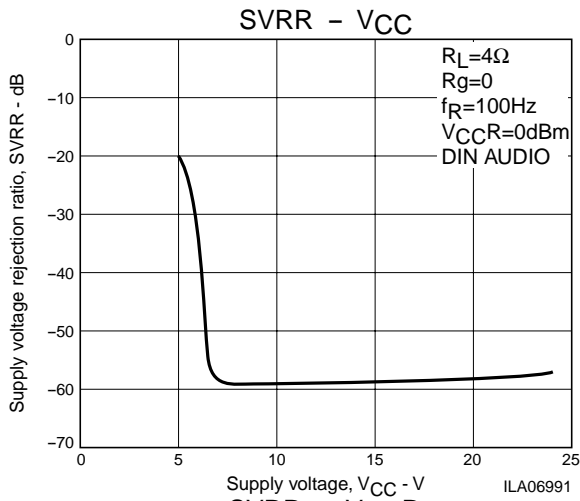

- Specifications of any and all SANYO products described or contained herein stipulate the performance, characteristics, and functions of the described products in the independent state, and are not guarantees of the performance, characteristics, and functions of the described products as mounted in the customer's products or equipment. To verify symptoms and states that cannot be evaluated in an independent device, the customer should always evaluate and test devices mounted in the customer's products or equipment.
- SANYO Electric Co., Ltd. strives to supply high-quality high-reliability products. However, any and all semiconductor products fail with some probability. It is possible that these probabilistic failures could give rise to accidents or events that could endanger human lives, that could give rise to smoke or fire, or that could cause damage to other property. When designing equipment, adopt safety measures so that these kinds of accidents or events cannot occur. Such measures include but are not limited to protective circuits and error prevention circuits for safe design, redundant design, and structural design.
- In the event that any or all SANYO products(including technical data, services) described or contained herein are controlled under any of applicable local export control laws and regulations, such products must not be exported without obtaining the export license from the authorities concerned in accordance with the above law.
- No part of this publication may be reproduced or transmitted in any form or by any means, electronic or mechanical, including photocopying and recording, or any information storage or retrieval system, or otherwise, without the prior written permission of SANYO Electric Co., Ltd.
- Any and all information described or contained herein are subject to change without notice due to product/technology improvement, etc. When designing equipment, refer to the "Delivery Specification" for the SANYO product that you intend to use.
- Information (including circuit diagrams and circuit parameters) herein is for example only ; it is not guaranteed for volume production. SANYO believes information herein is accurate and reliable, but no guarantees are made or implied regarding its use or any infringements of intellectual property rights or other rights of third parties.

This catalog provides information as of March, 2005. Specifications and information herein are subject to change without notice.